

# 任意波形信号发生器

AFG-2225

---

使用手册

固纬料号 **NO.82AFB22250EB1**



ISO-9001 认证企业

**GW INSTEK**

本手册所含资料受到版权保护，未经固纬电子实业股份有限公司预先授权，不得将手册内任何章节影印、复制或翻译成其它语言。

本手册所含资料在印制之前已经过校正，但因固纬电子实业股份有限公司不断改善产品，所以保留未来修改产品规格、特性以及保养维修程序的权利，不必事前通知。

# 目录

<b>安全说明</b> .....	<b>6</b>
<b>产品介绍</b> .....	<b>10</b>
主要特点.....	10
面板介绍.....	12
设置信号发生器.....	18
<b>快速操作</b> .....	<b>20</b>
如何使用数字输入.....	22
如何使用帮助菜单.....	24
选择波形.....	26
调制.....	28
Sweep.....	33
脉冲串.....	34
ARB.....	36
工具菜单.....	38
频率计.....	39
耦合.....	40
菜单树.....	42
默认设置.....	50
<b>操作</b> .....	<b>52</b>
选择波形.....	53
<b>调制</b> .....	<b>62</b>
幅值调制 (AM).....	64
频率调制 (FM).....	73
频移键控 (FSK) 调制.....	81
相位调制 (PM).....	88

SUM 调制 .....	97
频率扫描.....	105
脉冲串模式 .....	114
<b>辅助系统功能设置 .....</b>	<b>127</b>
存储和调取 .....	128
系统和设置 .....	131
<b>通道设置 .....</b>	<b>137</b>
<b>任意波形 .....</b>	<b>141</b>
插入内置波形.....	142
显示任意波形.....	144
编辑任意波形.....	153
输出任意波形.....	163
存储/调取任意波形 .....	165
<b>远程接口 .....</b>	<b>174</b>
Establishing a Remote Connection.....	175
Command List .....	183
System Commands .....	187
Status Register Commands .....	190
System Remote Commands .....	193
Apply Commands.....	194
Output Commands .....	200
Pulse Configuration Commands.....	209
Amplitude Modulation (AM) Commands .....	211
Frequency Modulation (FM) Commands .....	216
Frequency-Shift Keying (FSK) Commands .....	221
FSK Overview.....	221
Phase Modulation (PM) Commands .....	225
SUM Modulation (SUM) Commands .....	229
Frequency Sweep Commands.....	233

---

Burst Mode Commands .....	242
Arbitrary Waveform Commands .....	252
COUNTER .....	258
PHASE.....	260
COUPLE .....	261
Save and Recall Commands .....	264
Error Messages.....	266
SCPI Status Register .....	274
<b>APPENDIX .....</b>	<b>280</b>
AFG-2225 Specifications .....	280
EC Declaration of Conformity .....	285
<b>INDEX .....</b>	<b>298</b>









# 安全说明

本章节包含操作和存储信号发生器时必须遵照的重要安全说明。在操作前请详细阅读以下内容，确保安全和最佳化的使用。

## 安全符号

这些安全符号会出现在本使用手册或仪器上。

---

 警告	警告：产品在某一特定情况下或实际应用中可能对人体造成伤害或危及生命
 注意	注意：产品在某一特定情况下或实际应用中可能对产品本身或其它产品造成损坏
 高压危险	
 注意：请参考使用手册	
 保护导体端子	
 接地端子	
 表面高温危险	
 双层绝缘	



勿将电子设备作为未分类的市政废弃物处理。请单独收集处理或联系设备供应商

## 安全指南

---

### 通常



注意

- 勿将重物置于仪器上
- 勿将易燃物置于仪器上
- 避免严重撞击或不当放置而损坏仪器
- 避免静电释放至仪器
- 请使用匹配的连接线，切不可用裸线连接
- 若非专业技术人员，请勿自行拆装仪器

(测量等级) EN 61010-1:2010 规定了如下测量等级. AFG-2225 属于等级 II.

- 测量等级 IV: 测量低电压设备电源
- 测量等级 III: 测量建筑设备
- 测量等级 II: 测量直接连接到低电压设备的电路
- 测量等级 I: 测量未直接连接电源的电路

---

### 电源



警告

- AC 输入电压: 100 ~ 240V AC, 50 ~ 60Hz
- 将交流电源插座的保护接地端子接地，避免电击触电

---

### 保险丝



警告

- 保险丝类型: F1A/250V
- 请专业技术人员更换保险丝
- 请更换指定类型和额定值的保险丝
- 更换前请断开电源插座和所有测试线
- 更换前请查明保险丝的熔断原因

---

### 清洁仪器

- 清洁前先切断电源
  - 以中性洗涤剂和清水沾湿软布擦拭仪器。不要直接将任何液体喷洒到仪器上
  - 不要使用含苯，甲苯，二甲苯和丙酮等烈性物质的化学药品或清洁剂
-

---

操作环境	<ul style="list-style-type: none"><li>• 地点: 室内, 避免阳光直射, 无灰尘, 无导电污染(下注), 避免强磁场</li><li>• 相对湿度: &lt; 80%</li><li>• 海拔: &lt; 2000m</li><li>• 温度: 0°C~40°C</li></ul> <p>(污染等级) EN 61010-1:2010 规定了如下污染程度. AFG-2225 属于等级 2.</p> <p>污染指“可能引起绝缘强度或表面电阻率降低的外界物质, 固体, 液体或气体(电离气体)”。</p> <ul style="list-style-type: none"><li>• 污染等级 1: 无污染或仅干燥, 存在非导电污染, 污染无影响</li><li>• 污染等级 2: 通常只存在非导电污染, 偶尔存在由凝结物引起的短暂导电</li><li>• 污染等级 3: 存在导电污染或由于凝结原因使干燥的非导电性污染变成导电性污染。此种情况下, 设备通常处于避免阳光直射和充分风压条件下, 但温度和湿度未受控制</li></ul>
存储环境	<ul style="list-style-type: none"><li>• 地点: 室内</li><li>• 相对湿度: &lt; 70%</li><li>• 温度: -10°C ~ 70°C</li></ul>
处理	<p>勿将电子设备作为未分类的市政废弃物处理。请单独收集处理或联系设备供应商。请务必妥善处理丢弃的电子废弃物, 减少对环境的影响</p>

---





## 英制电源线

在英国使用信号发生器时，确保电源线符合以下安全说明。

注意：导线/设备连接必须由专业人员操作。

警告：此装置必须接地

重要：导线颜色应与下述规则保持一致：

绿色/黄色：        接地  
蓝色：                零线  
棕色：                火线(相线)



导线颜色可能与插头/仪器中所标识的略有差异，请遵循如下操作：

颜色为绿色/黄色的线需与标有字母“E”，或接地标志⊕，或颜色为绿色/黄绿色的接地端子相连。

颜色为蓝色的线需与标有字母“N”，或颜色为蓝色或黑色的端子相连。

颜色为棕色的线需与标有字母“L”或“P”，或者颜色为棕色或红色的端子相连。

若有疑问，请参照本仪器提供的用法说明或与经销商联系。

电缆/仪器需有符合额定值和规格的 HBC 保险丝保护：保险丝额定值请参照仪器说明或使用手册。如：0.75mm<sup>2</sup> 的电缆需要 3A 或 5A 的保险丝。保险丝型号与连接方法有关，大的导体通常应使用 13A 保险丝。

将带有裸线的电缆、插头或其它连接器与火线插座相连非常危险。若已确认电缆或插座存在危险，必须关闭电源，拔下电缆、保险丝和保险丝座。并且根据以上标准立即更换电线和保险丝。

# 产品介绍

本章节介绍了信号发生器的主要特点、外观、设置步骤和开机。

## 主要特点

型号	带宽
AFG-2225	25MHz
性能	<ul style="list-style-type: none"> <li>• DDS 信号发生器系列</li> <li>• 全范围 1<math>\mu</math>Hz 高频率分辨率</li> <li>• 20ppm 频率稳定度</li> <li>• 任意波形能力</li> <li>120 MSa/s 采样率</li> <li>60 MSa/s 重建率</li> <li>4k 点波形长度</li> <li>10 组 4k 波形存储器</li> <li>显示真实波形输出</li> <li>用户自定义输出</li> <li>DWR (直接波形重建)能力</li> <li>PC 波形编辑</li> </ul>
特点	<ul style="list-style-type: none"> <li>• 正弦波, 方波, 斜波, 脉冲波, 噪声波标准波形</li> <li>• 内部和外部 LIN/LOG 扫描, 带标记输出</li> <li>• Int/Ext AM, FM, PM, FSK, SUM 调制</li> <li>• 带内部和外部触发的脉冲串功能, 无标记输出</li> <li>• 存储/调取 10 组设置存储器</li> </ul>

- 
- 输出过载保护
- 







接口

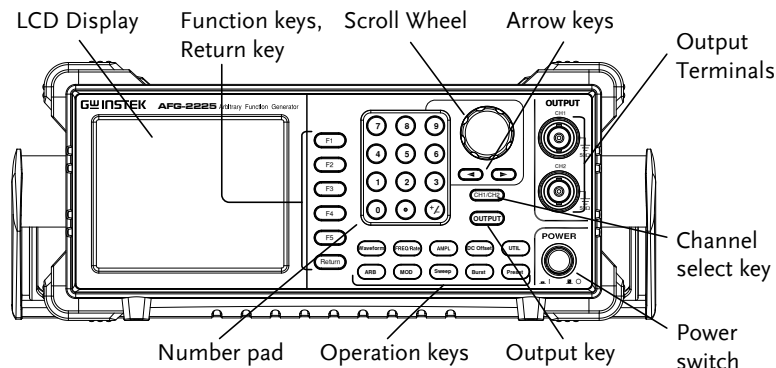







- 标配 USB 接口
- 3.5" 彩色 TFT LCD (320 X 240)
- AWES (任意波形编辑软件) PC 软件

## 面板介绍

### 前面板

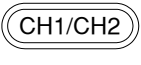
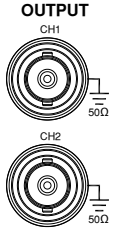

LCD Display	TFT 彩色显示器, 分辨率 320 x 240	
Function Keys F1~F5		位于 LCD 屏右侧, 开启功能
Return Key		返回上一层菜单
Operation Keys		用于选择波形类型
		用于设置频率或采样率
		用于设置波形幅值
		设置直流偏置
		用于进入存储和调取选项、更新和查阅固件版本、进入校正选项、输出阻抗设置和频率计

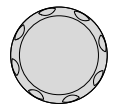
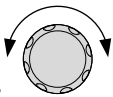
		用于设置任意波形参数
		MOD, Sweep 和 Burst 键用于设置调制、扫描和脉冲串选项和参数
		
		
Preset Key		用于调取预设状态
Output Key		用于开启或关闭波形输出
Channel Select Key		用于切换两个输出通道
Output ports	 <p>OUTPUT CH1</p> <p>CH2</p> <p>50Ω</p>	<p>CH1:通道 1 输出端口</p> <p>CH2:通道 2 输出端口</p>
Power Button		开关机
Arrow Keys		编辑参数时，可用于选择数字
Scroll Wheel	 	<p>用于编辑数值和参数</p> <p>减小      增加</p>

---

Keypad

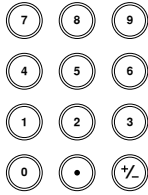

用于键入数值和参数，常与方向键和可调旋钮一起使用

---

后面板

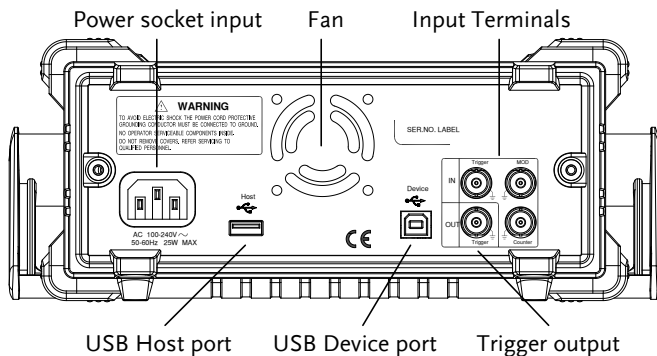

Trigger Input

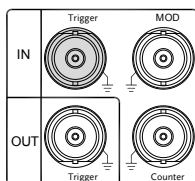

外部触发输入。用于接收外部触发信号

Trigger Output

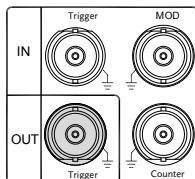

标记输出信号。仅用于扫描和 ARB 模式

Fan

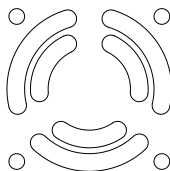

风扇

Power Input Socket

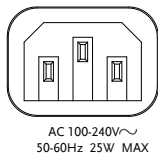

电源输入: 100~240V AC  
50~60Hz

USB Host



USB type-A host 接口

USB Device Port

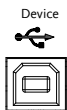

USB type-B device 接口用于连接 PC 机，可进行远程控制

Counter Input

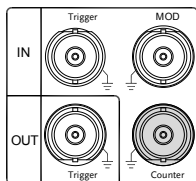

频率计输入端子

MOD Input

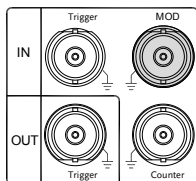

调制输入端子



## 显示



Parameter Windows 显示参数和编辑窗口

Status Tabs 显示当前通道和设置状态

Waveform Display 显示波形

Soft Menu Keys 功能键(F1~F5)与左侧的软菜单键对应

## 设置信号发生器

背景 本章节介绍了如何调整信号发生器的把手以及如何开机。

调整把手

将把手向两侧拉伸并旋转

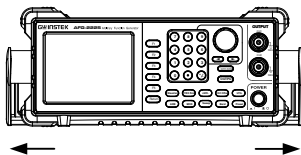

水平放置 AFG-2225

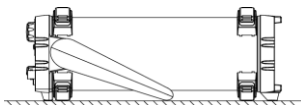

或倾斜放置

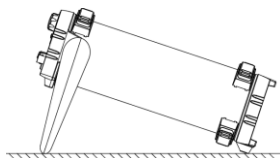

手把垂直放置以方便手提

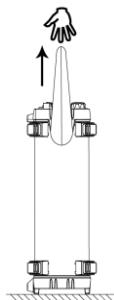

开机

1. 将电源线插入后面板插座

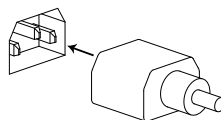

2. 开启位于前面板的电源开关



3. 按下电源开关后，屏幕显示载入状态



信号发生器已准备就绪。

# 快速操作

本章节介绍了操作快捷方式、内置帮助和默认出厂设置，方便用户快速入门。有关参数、设置和限制的详细内容，见操作章节。

如何使用数字输入 .....	22
如何使用帮助菜单 .....	24
选择波形 .....	26
方波 .....	26
斜波 .....	26
正弦波 .....	27
调制 .....	28
AM .....	28
FM .....	29
FSK 调制 .....	30
PM 调制 .....	31
SUM 调制 .....	32
Sweep .....	33
脉冲串 .....	34
ARB .....	36
ARB-增加内置波形 .....	36
ARB-增加点 .....	36
ARB-增加线 .....	37
ARB-输出部分 .....	37
工具菜单 .....	38
存储 .....	38
调取 .....	38
频率计 .....	39
频率计 .....	39
耦合 .....	40
频率耦合 .....	40

---

幅值耦合 .....	40
追踪 .....	41
菜单树 .....	42
波形 .....	42
ARB-显示 .....	43
ARB-编辑 .....	44
ARB-内置 .....	44
ARB-存储 .....	45
ARB-调取 .....	45
ARB-输出 .....	46
MOD .....	46
SWEEP .....	47
SWEEP-更多 .....	47
脉冲串- N 次循环 .....	48
脉冲串-门限 .....	48
UTIL .....	49
CH1/CH2 .....	49

## 如何使用数字输入

背景

AFG-2225 有三类主要的数字输入：数字键盘、方向键和可调旋钮。下面将为您介绍如何使用数字输入编辑参数。

1. 按(F1~F5)对应功能键选择菜单项。例如，功能键 F1 对应软键“Sine”



2. 使用方向键将光标移至需要编辑数值的位置



CH1 ON 50 Ω	CH2 OFF 50 Ω
FREQ: 1.000000 kHz	FREQ: 1.000000 kHz
AMPL: 3.000 VPP	AMPL: 3.000 VPP
Offset: 0.00 VDC	Offset: 0.00 VDC
Phase: 0.0 °	Phase: 0.0 °

3. 使用可调旋钮编辑数值。顺时针增大，逆时针减小

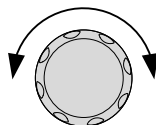

4. 数字键盘用于设置高光处的参  
数值

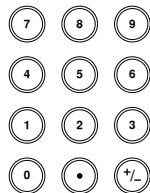

## 如何使用帮助菜单

背景 帮助菜单详细描述了每个键的含义及功能。

1. 按 UTIL



2. 按 System (F3)



3. 按 Help (F2)

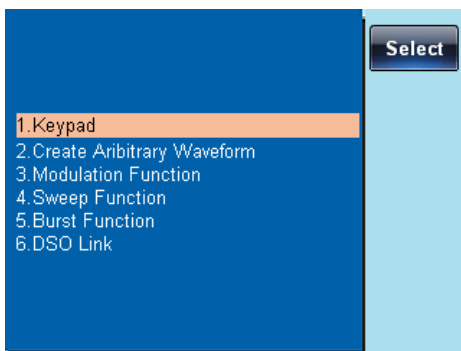

4. 可调旋钮用于浏览帮助内容。  
按 Select 选择该项

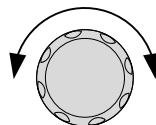

- |                           |             |
|---------------------------|-------------|
| Keypad                    | 解释任一前面板键的含义 |
| Create Arbitrary Waveform | 解释如何创建任意波形  |
| Modulation Function       | 解释如何创建调制波形  |
| Sweep Function            | 解释 Sweep 功能 |
| Burst Function            | 解释脉冲串功能     |



## DSO Link 解释 DSO 连接

5. 例如，选项 4 可以查看 Sweep 功能

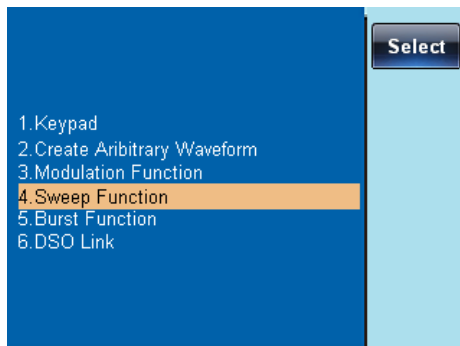

6. 使用可调旋钮浏览帮助信息

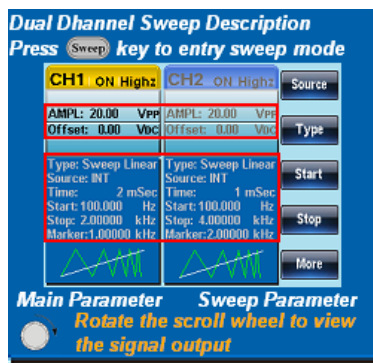

7. 按 Return 返回上一层菜单

Return

## 选择波形

### 方波

例如: 方波, 3Vpp, 75%占空比, 1 kHz

输出:

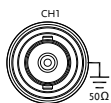

1. 按 Waveform 键, 选择 Square (F2)



2. 按 Duty (F1), 7 + 5 + % (F2)



输入: N/A

3. 按 Freq/Rate, 1 + kHz (F4)



4. 按 AMPL, 3 + VPP (F5)



5. 按 Output 键



### 斜波

例如: 斜波, 5Vpp, 10kHz, 50%对称度

输出:

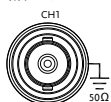

1. 按 Waveform 键, 选择 Ramp (F4)



2. 按 SYM(F1), 5 + 0 + % (F2)



输入: N/A

3. 按 Freq/Rate, 1 + 0 + kHz (F4)



4. 按 AMPL, 5 + VPP (F5)



## 5. 按 Output 键



## 正弦波

例如: 正弦波, 10Vpp, 100kHz

输出:

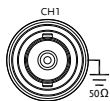

输入: N/A

1. 按 Waveform 键, 选择 Sine (F1)



2. 按 Freq/Rate, 1 + 0 + 0 + kHz (F4)



3. 按 AMPL, 1 + 0 + VPP (F5)



4. 按 Output 键









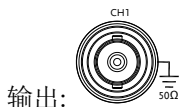





















# 调制

## AM

例如: AM 调制. 100Hz 调制方波. 1kHz 正弦载波. 80% 调制深度



输入: N/A



1. 按 MOD 键, 选择 AM (F1)  
2. 按 Waveform, 选择 Sine (F1)  
3. 按 Freq/Rate, 1 + kHz (F4)   
4. 按 MOD 键, 选择 AM (F1), Shape (F4), Square (F2)    
5. 按 MOD 键, 选择 AM (F1), AM Freq (F3)   
6. 按 1 + 0 + 0 + Hz (F2)    
7. 按 MOD 键, 选择 AM (F1), Depth (F2)   
8. 按 8 + 0 + % (F1)   
9. 按 MOD, AM (F1), Source (F1), INT (F1)    
10. 按 Output 键 



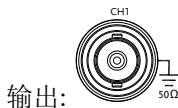



## FM

例如: FM 调制. 100Hz 调制方波, 1kHz 正弦载波. 100 Hz 频移. 内部源



输入: N/A

1. 按 MOD 键, 选择 FM (F2)  
2. 按 Waveform, 选择 Sine (F1)  
3. 按 Freq/Rate key, 1 + kHz (F4)   
4. 按 MOD, 选择 FM (F2), Shape (F4), Square (F2)     







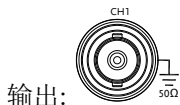















5. 按 MOD, 选择 FM (F2), FM Freq (F3)   
6. 按 1 + 0 + 0 + Hz (F2)    
7. 按 MOD, 选择 FM (F2), Freq Dev (F2)   
8. 按 1 + 0 + 0 + Hz (F3)    
9. 按 MOD, FM (F2), Source (F1), INT (F1)     

10. 按 Output 键 

## FSK 调制

例如: FSK 调制, 100Hz 跳跃频率, 1kHz 载波, 正弦波, 10 Hz 频率, 内部源



输入: N/A







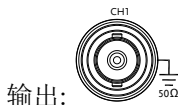























1. 按 MOD 键, 选择 FSK (F3)  
2. 按 Waveform, 选择 Sine (F1)  
3. 按 Freq/Rate, 1 + kHz (F4)   
4. 按 MOD 键, 选择 FSK (F3), FSK Rate (F3)   
5. 按 1 + 0 + Hz (F2)   
6. 按 MOD 键, 选择 FSK (F3), Hop Freq (F2)   
7. 按 1 + 0 + 0 + Hz (F3)    
8. 按 MOD, FSK (F3), Source (F1), INT (F1)     

9. 按 Output 键 

## PM 调制

例如: PM 调制. 800Hz 正弦载波. 15kHz 调制正弦波. 50°相位偏移. 内部源



输入: N/A

1. 按 Waveform, 选择 Sine (F1)  
2. 按 MOD 键, 选择 PM (F4)  
3. 按 Freq/Rate, 8 + 0 + 0 + Hz (F3)     
4. 按 MOD 键, 选择 PM (F4), Shape (F4), Sine (F1)    
5. 按 MOD, PM (F4), PM Freq (F3)   
6. 按 1 + 5 + kHz (F3)   
7. 按 MOD, PM (F4), PM Dev (F2)   
8. 按 5 + 0 + Degree (F1)   
9. 按 MOD, PM (F4), Source (F1), INT (F1)    
10. 按 Output 键 

## SUM 调制

例如: SUM 调制. 100Hz 调制方波, 1kHz 正弦载波, 50% SUM 幅值, 内部源

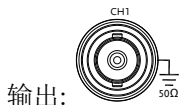

输入: N/A

1. 按 MOD 键, 选择 SUM (F5)
 
2. 按 Waveform, 选择 Sine (F1)
 
3. 按 Freq/Rate, 1 + kHz (F4).
 
4. 按 MOD 键, SUM (F5), Shape (F4), Square (F2)
 
5. 按 MOD 键, 选择 SUM (F5), SUM Freq (F3)
 
6. 按 1 + 0 + 0 + Hz (F2)
 
7. 按 MOD 键, 选择 SUM (F5), SUM Ampl (F2)
 
8. 按 5 + 0 + % (F1)
 
9. 按 MOD, SUM (F5), Source (F1), INT (F1)
 
10. 按 Output 键
 







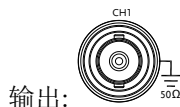

























## Sweep

例如: 频率扫描. 起始频率 10mHz, 截止频率 1MHz. Log 扫描, 1 s 扫描, 标记频率 550 Hz, 手动触发



输入: N/A







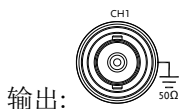























1. 按 Sweep, Start (F3)  
2. 按 1 + 0 + mHz (F2)   
3. 按 Sweep, Stop (F4)  
4. 按 1 + MHz (F5)  
5. 按 Sweep, Type (F2), Log (F2)   
6. 按 Sweep, More (F5), SWP Time (F1)   
7. 按 1 + SEC (F2)  
8. 按 Sweep, More (F5), Marker (F4), ON/OFF (F2), Freq (F1)     
9. 按 5 + 5 + 0 + Hz (F3)    
10. 按 Output 键 
11. 按 Sweep, Source (F1), Manual (F3), Trigger (F1)    

## 脉冲串

例如: 脉冲串模式, N 次循环(内部触发), 1kHz 脉冲串频率, 脉冲串数= 5, 10 ms 脉冲串周期, 0° 脉冲串相位, 内部触发, 10 us 延迟, 上升沿触发



输入: N/A

1. 按 **FREQ/Rate** 1 kHz (F4)   
2. 按 **Burst**, **N Cycle** (F1), **Cycles** (F1)   
3. 按 **5 + Cyc** (F2)  
4. 按 **Burst**, **N Cycle** (F1), **Period** (F4)   
5. 按 **1 + 0 + msec** (F2)   
6. 按 **Burst**, **N Cycle** (F1), **Phase** (F3)   
7. 按 **0 + Degree** (F2)  
8. 按 **Burst**, **N Cycle** (F1), **TRIG set** (F5), **INT** (F1)     

9. 按 **Burst**, **N Cycle** (F1), **TRIG set** (F5), **Delay** (F4)     

10. 按 **1 + 0 + uSEC** (F2)   

11. 按 Burst, N Cycle  
(F1), TRIG set (F5),  
TRIG out (F5),  
ON/OFF (F3), Rise  
(F1)



12. 按 Output 键



## ARB

### ARB-增加内置波形

例如: ARB 模式, 上升指数函数. Start 0, Length 100, Scale 327

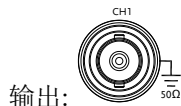

1. 按 ARB, Built in (F3), Wave (F4), Math(F2), 使用可调旋钮选择 Exporise, 然后按 Select(F5)



2. 按 Start (F1), 0 + Enter (F2), Return



3. 按 Length (F2), 100, Enter (F2), Return



4. 按 Scale (F3), 327, Enter (F2), Return, Done (F5)



### ARB-增加点

例如: ARB 模式, 增加点, 地址 40, 数据 300

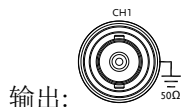

1. 按 ARB, Edit (F2), Point (F1), Address (F1)



2. 按 4 + 0 + Enter (F2), Return



3. 按 Data (F2), 3+0+0, Enter (F2)



## ARB-增加线

例如: ARB 模式, 增加线, 地址: 数据(10:30, 50:100)

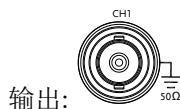

1. 按 ARB, Edit (F2), Line (F2), Start ADD (F1)



2. 按 1 + 0 + Enter (F2), Return



3. 按 Start Data (F2), 3 + 0, Enter (F2), Return

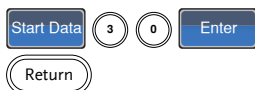

4. 按 Stop ADD (F3), 5 + 0, Enter (F2), Return

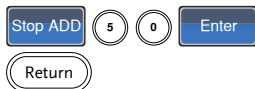

5. 按 Stop Data (F4), 1 + 0 + 0, Enter (F2), Return, Done (F5)

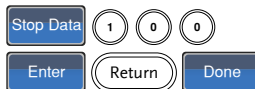

## ARB-输出部分

例子: ARB 模式, 输出 ARB 波形, Start 0, Length 1000

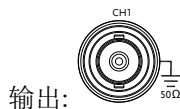

1. 按 ARB, Output (F4)



2. 按 Start (F1), 0 + Enter (F2), Return

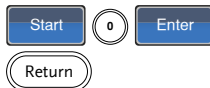

3. 按 Length (F2), 1 + 0 + 0, Enter (F2), Return

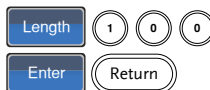

## 工具菜单

### 存储

---

例如: 存储至内存文件#5

1. 按 UTIL, Memory (F1), Store (F1)



2. 使用可调旋钮选择一个设置, 按 Done (F5)



### 调取

---

例如: 调取内存文件#5

1. 按 UTIL, Memory (F1), Recall (F2)



2. 使用可调旋钮选择一个设置, 按 Done (F5)

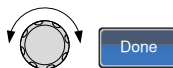

# 频率计

## 频率计

---

例如: 开启频率计。门限时间: 1 s

输出: N/A

1. 按 UTIL, Counter (F5)



输入:

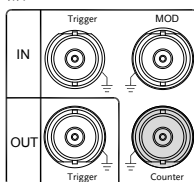

2. 按 Gate Time (F1), 按  
1 Sec (F3)选择 1 s 的  
门限时间



3. 将感兴趣的信号接入后面板的频率计输入端

## 耦合

### 频率耦合

---

例如: 频率耦合

1. 按 UTIL, Dual Chan (F4)进入耦合功能  
2. 按 Freq Cpl (F1)选择频率耦合功能 
3. 按 Offset (F2). 设置 CH1 和 CH2 之间的频率差. 使用数字键或可调旋钮输入偏差 

### 幅值耦合

---

例如: 幅值耦合

1. 按 UTIL, Dual Chan (F4)进入耦合功能  
2. 按 Ampl Cpl (F2), ON (F1)选择幅值耦合功能  
3. 设置两通道的幅值和偏移耦合. 在当前通道的任何幅值改变都将影响另一通道



## 追踪

---

例如: 追踪

1. 按 UTIL, Dual Chan (F4)进入耦合功能  
2. 按 Tracking (F3), ON (F2)开启追踪功能  
3. 开启追踪功能时, 当前通道参数如幅值和频率将反映到另一通道

## 菜单树

---

常规

用户可以参考菜单树对信号发生器的功能和特性做一大致了解。AFG-2225 菜单系统逐层排列，每层都由操作或软菜单键导航。返回键(Return)用于返回上级菜单。

波形

---

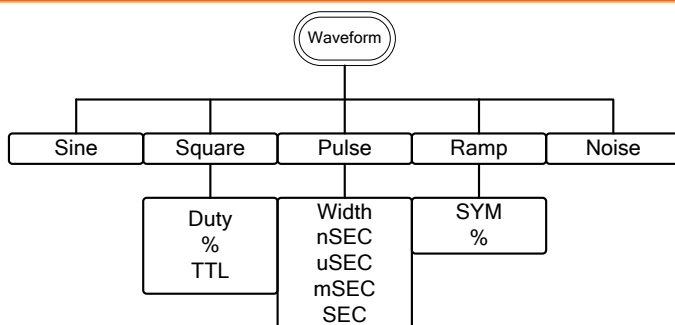

ARB-显示

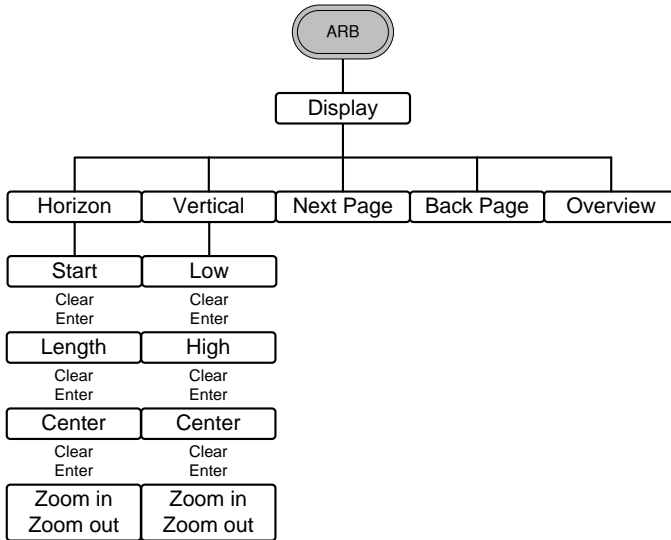

ARB-编辑

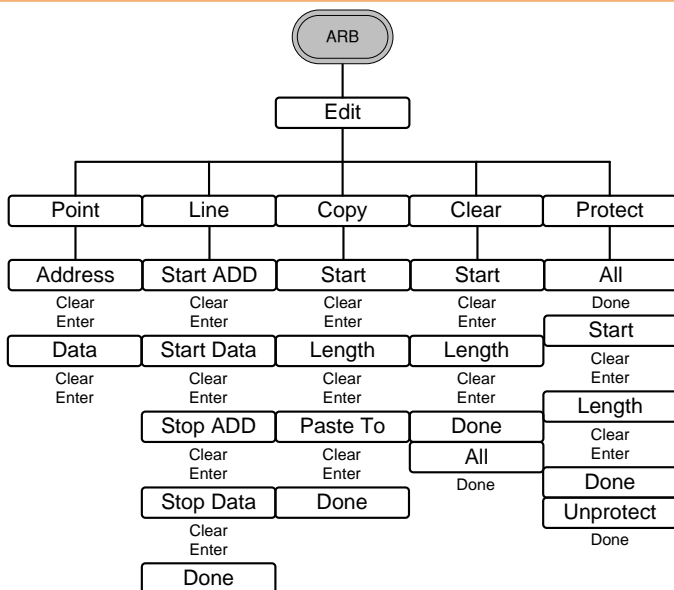

ARB-内置

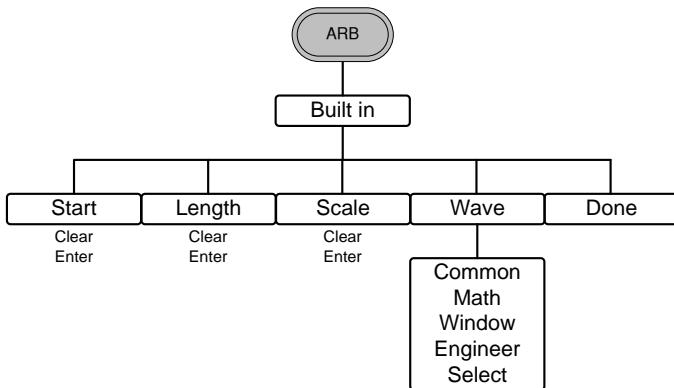

## ARB-存储

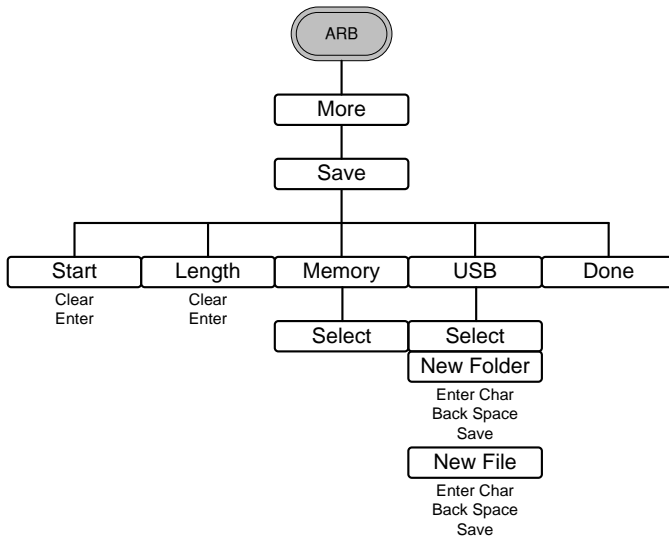

## ARB-调取

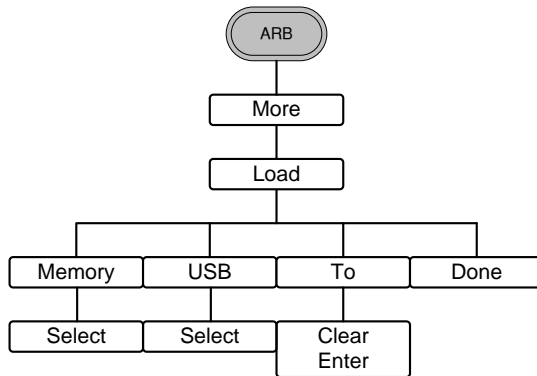

## ARB-输出

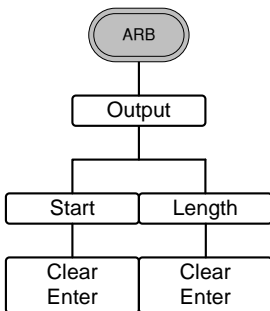

## MOD

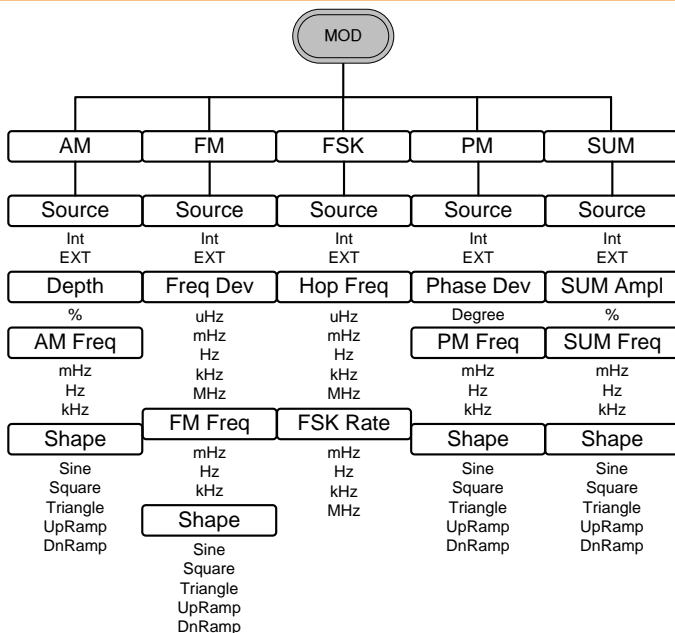

## SWEEP

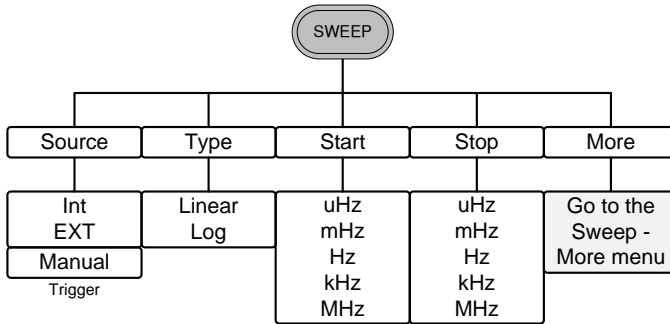

## SWEEP-更多

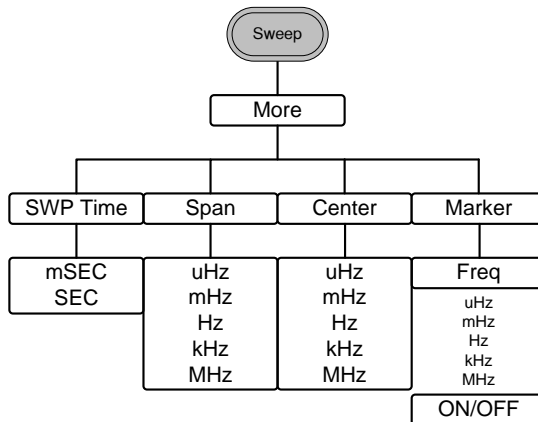

脉冲串- N 次循环

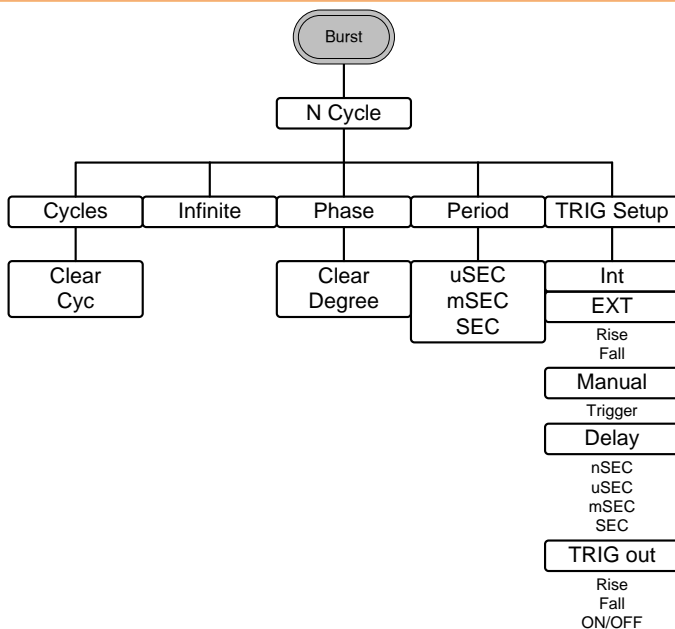

脉冲串-门限

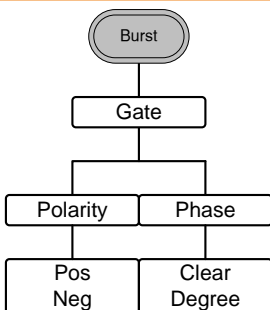



## UTIL

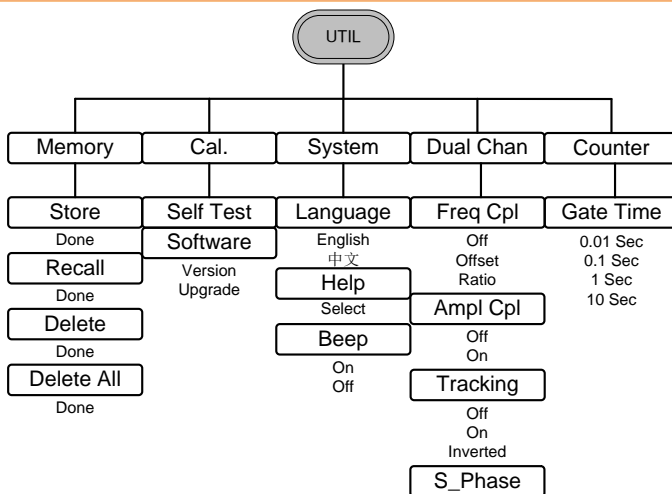

## CH1/CH2

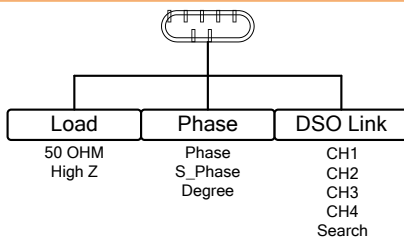

## 默认设置

Preset 键用于恢复默认面板设置。



输出设置	功能	正弦波
	频率	1kHz
	幅值	3.000 V <sub>pp</sub>
	偏移	0.00V dc
	输出单位	V <sub>pp</sub>
	输出端	50Ω
调制 (AM/FM/FSK/ PM/SUM)	载波	1kHz 正弦波
	调制波形	100Hz 正弦波
	AM 深度	100%
	FM 偏移	100Hz
	FSK 跳跃频率	100Hz
	FSK 频率	10Hz
	PM 相位偏移	180°
	SUM 幅值	50%
	调制解调器状态	Off
Sweep	起始/停止频率	100Hz/1kHz
	扫描时间	1s
	扫描类型	线性
	扫描状态	Off

脉冲串	脉冲串频率	1kHz
	N 次循环	1
	脉冲串周期	10ms
	脉冲串起始相位	0°
	脉冲串状态	Off
系统设置	断电调用信号	On
	显示模式	On
	错误队列	清除
	存储器设置	无更改
	输出	Off
触发	触发源	内部(立即)
校准	校准菜单	加密

# 操作

本章节介绍如何输出基本波形。有关调制、扫描、脉冲串和任意波形的详细内容，见 62 和 141 页。

---

选择波形 .....	53
正弦波 .....	53
方波 .....	54
设置脉冲宽度 .....	55
设置斜波 .....	56
选择噪声波 .....	57
设置频率 .....	58
设置幅值 .....	60
设置 DC 偏移 .....	61

## 选择波形

AFG-2225 可以输出 5 种标准波形：正弦波、方波、脉冲波、斜坡和噪声波。

### 正弦波

面板操作

1. 按 Waveform 键



2. 按 F1 (Sine)

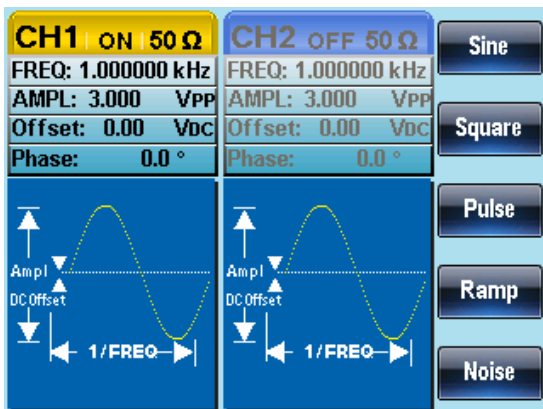

## 方波

面板操作

1. 按 Waveform 键



2. 按 F2 (Square)



3. 按 F1 (Duty). 在参数窗口内的占空比参数变亮

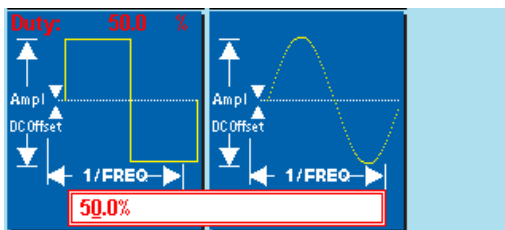

4. 使用方向键和可调旋钮或数字键盘输入占空比范围

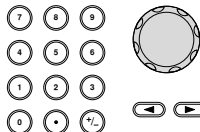

5. 按 F2 (%)选择%单位



范围

频率

占空比范围

≤100kHz

1.0%~99.0%

100kHz~≤1MHz

10.0%~90.0%

>1MHz~25MHz

50% (固定)

TTL 功能是把当前方波的幅度设为 2.5Vpp,同时将 DC Offset 设为 1.25Vdc.

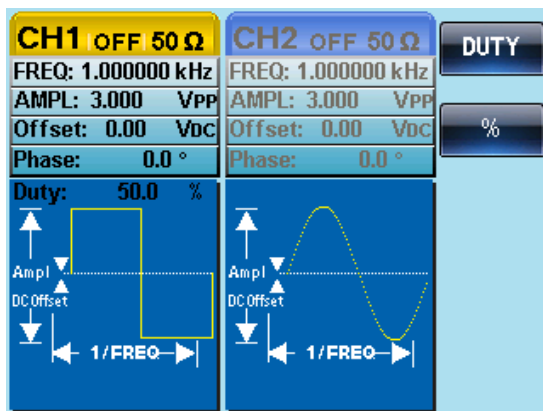

## 设置脉冲宽度

面板操作

1. 按 Waveform 键



2. 按 F3 (Pulse)



3. 按 F1 (Width). 在参数窗口内的宽度参数变亮

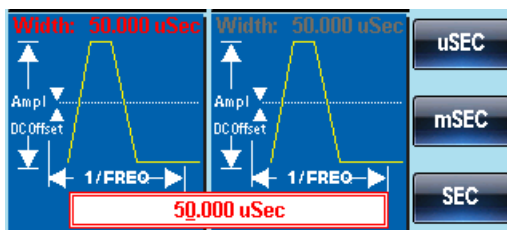

4. 使用方向键和可调旋钮或数字键盘输入脉冲宽度

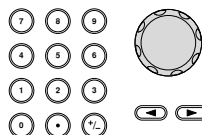

5. 按 F2~F5 选择单位范围

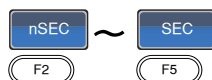

范围	脉冲宽度	20ns~1999.9s
! 注意	最小脉冲宽度	频率 ≤ 25MHz: 20ns 脉冲宽度 频率 ≤ 100 kHz: 1/4096 占空比
	分辨率	频率 ≤ 25MHz: 20ns 脉冲宽度 频率 ≤ 100 kHz: 1/4096 占空比

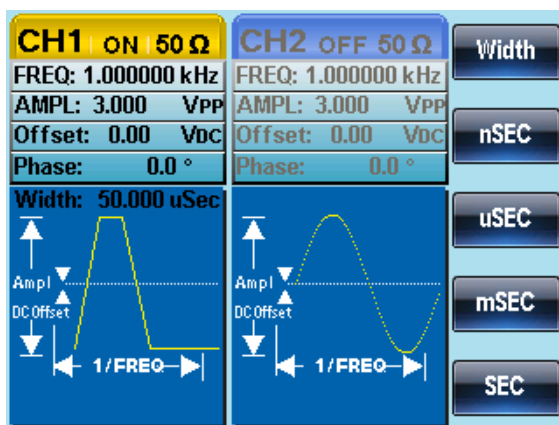

## 设置斜波

面板操作

1. 按 Waveform



2. 按 F4 (Ramp)



3. 按 F1 (SYM). 在参数窗口内的 SYM 参数变亮





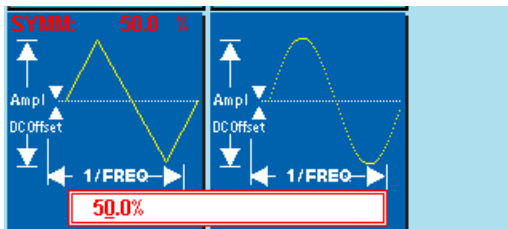

4. 使用方向键和可调旋钮或数字键盘输入对称比率

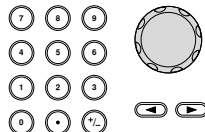

5. 按 F2 (%)选择%单位



范围

对称

0%~100%

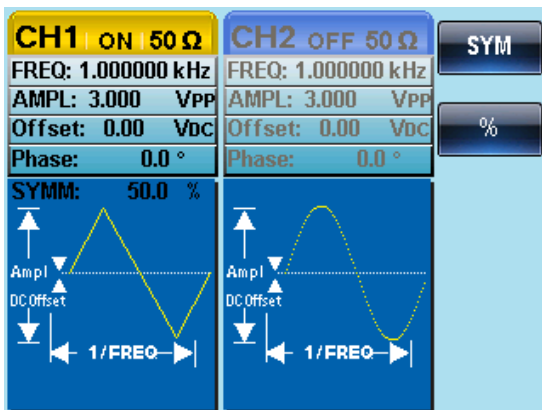

## 选择噪声波

面板操作

1. 按 Waveform 键



2. 按 F5 (Noise)



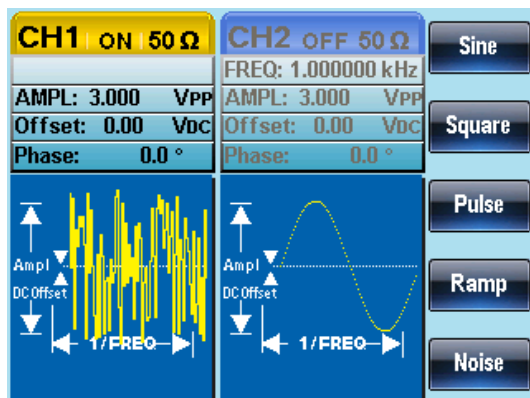

## 设置频率

### 面板操作

1. 按 FREQ/Rate 键



2. 在参数窗口内的 FREQ 参数变亮



3. 使用方向键和可调旋钮或数字键盘输入频率

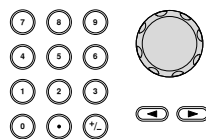

4. 按 F1~F5 选择频率单位

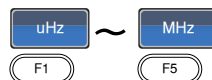

### 范围

正弦波	1 $\mu$ Hz~25MHz
方波	1 $\mu$ Hz~25MHz
脉冲波	500 $\mu$ Hz~25MHz

斜波 1 $\mu$ Hz~1MHz

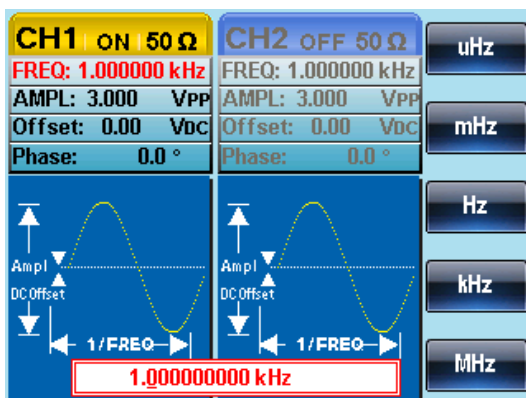

## 设置幅值

面板操作

1. 按 AMPL 键



2. 在参数窗口内的 AMPL 参数变亮

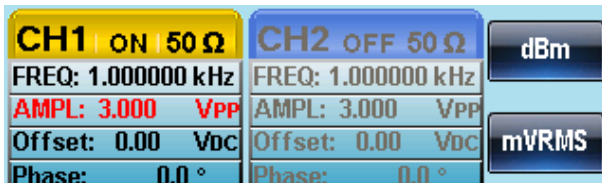

3. 使用方向键和可调旋钮或数字键盘输入幅值

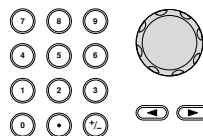

4. 按 F1~F5 选择单位

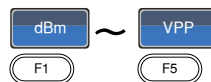

50Ω 负载

高阻抗

范围

1mVpp~10Vpp

2mVpp~20Vpp

单位

Vpp, Vrms, dBm

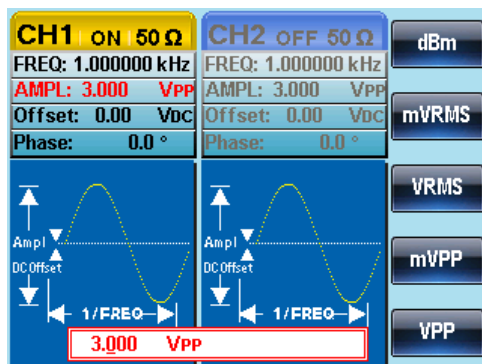

## 设置 DC 偏移

面板操作

1. 按 DC Offset 键



2. 在参数窗口内的 DC Offset 参数变亮

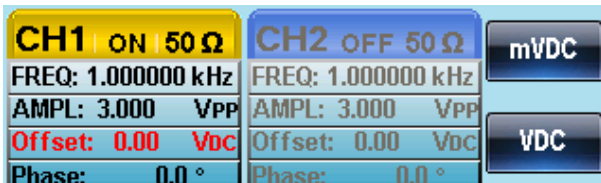

3. 使用方向键和可调旋钮或数字键盘输入 DC 偏移

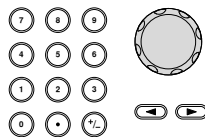

4. 按 F1 (mVDC)或 F2 (VDC)选择电压范围



50Ω 负载

高阻抗

范围

±5Vpk

±10Vpk

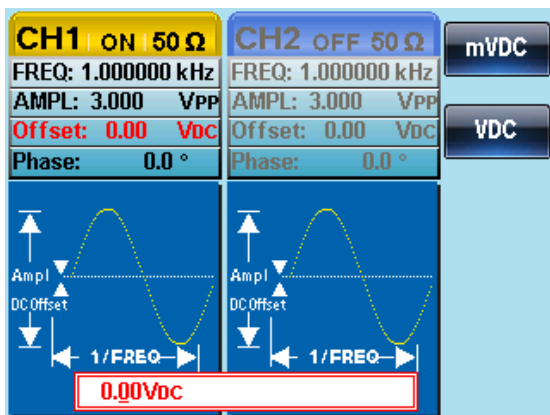

# 调制

AFG-2225 任意波形信号发生器能够产生 AM, FM, FSK, PM 和 SUM 调制波形。调制类型不同，调制参数的设置也有所不同。无论何时，只允许执行一种调制模式，且扫描或脉冲串模式不能与 AM/FM 同时启用。开启一个调制模式，就意味着关闭前一个调制模式。

幅值调制 (AM)	64
选择 AM 调制	65
AM 载波波形	65
载波频率	66
调制波形	67
AM 频率	68
调制深度	70
选择 (AM) 调制源	71
频率调制 (FM)	73
选择 FM 调制	74
FM 载波波形	74
FM 载波频率	75
FM 波形	76
FM 频率	77
频率偏移	78
选择 (FM) 调制源	79
频移键控 (FSK) 调制	81
选择 FSK 调制	82
FSK 载波波形	82
FSK 载波频率	83
FSK 跳跃频率	84
FSK 频率	85
FSK 调制源	87
相位调制 (PM)	88
选择 PM 调制	89
PM 载波波形	90

PM 载波频率.....	90
PM 波形.....	91
PM 频率.....	92
相位偏移.....	94
选择 PM 调制源.....	95
SUM 调制.....	97
选择 SUM 调制.....	98
SUM 载波波形.....	98
SUM 载波频率.....	99
SUM 波形.....	100
调制波形频率.....	101
SUM 幅值.....	102
选择 SUM 调制源.....	103
频率扫描.....	105
选择 Sweep 模式.....	106
设置起始和停止频率.....	106
中心频率和跨距.....	107
扫描模式.....	109
扫描时间.....	110
标记频率.....	111
扫描触发源.....	112
脉冲串模式.....	114
选择脉冲串模式.....	115
脉冲串模式.....	115
脉冲串频率.....	116
脉冲串循环/计数.....	117
无限脉冲串计数.....	119
脉冲串周期.....	119
脉冲串相位.....	121
脉冲串触发源.....	122
脉冲串延迟.....	124
脉冲串触发输出.....	125

## 幅值调制(AM)

AM 波形由载波和调制波组成。载波幅值与调制波幅值有关。AFG-2225 信号发生器可以设置载波频率、幅值、偏置电压以及内部或外部调制源。

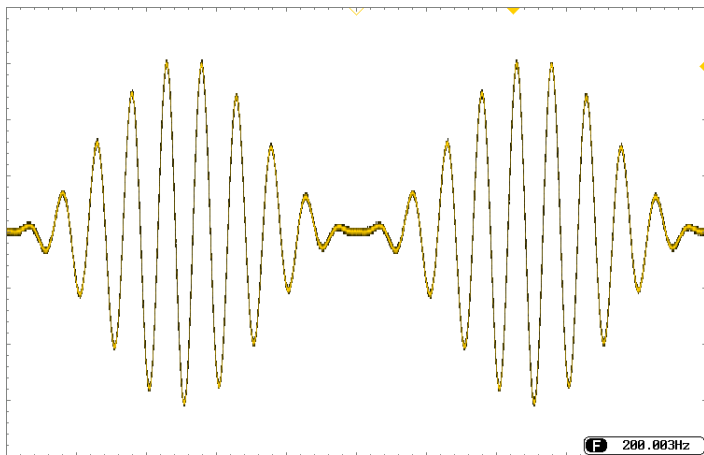



## 选择 AM 调制

面板操作

1. 按 MOD 键



2. 按 F1 (AM)

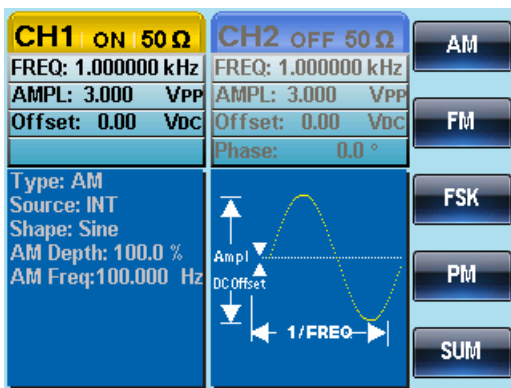

## AM 载波波形

背景

AM 载波波形：正弦波、方波、斜波、脉冲波或任意波，默认为正弦波。噪声波不可用作载波。在选择载波波形前，请先选择 AM 调制模式。

选择一个标准载波波形

1. 按 Waveform 键



2. 按 F1~F4 选择载波

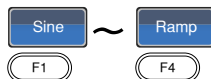

选择任意波作为载波 3. 有关任意波的使用，见任意波快速指南或章节 见 36 页  
见 141 页

范围 AM 载波波形 正弦波, 方波, 斜波, 脉冲波, 任意波

### 载波频率

最大载波频率与所选的载波波形有关，默认载波频率为 1kHz。

#### 面板操作

- 按 **FREQ/Rate** 键选择载波频率 
- 在参数窗口内的 **FREQ** 参数变亮

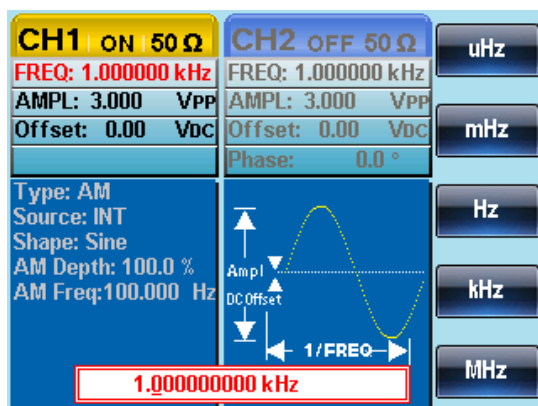

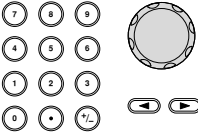
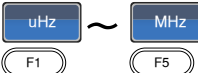
- 使用方向键和可调旋钮或数字键盘输入载波频率 
- 按 **F1~F5** 选择频率单位 

范围 载波波形 载波频率  
正弦波 1μHz~ 25MHz

方波	1 $\mu$ Hz~25MHz
斜波	1 $\mu$ Hz~1MHz
脉冲波	500uHz~25MHz
默认频率	1 kHz

## 调制波形

信号发生器可以接收内部和外部源。AFG-2225 的调制波形包括正弦波、方波、三角波、上斜波、下斜波，默认为正弦波。

### 面板操作

1. 按 MOD 键



2. 按 F1 (AM)



3. 按 F4 (Shape)



4. 按 F1 ~ F5 选择波形

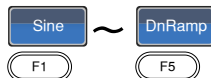

5. 按 Return 返回上层菜单



### 注意

方波	50% 占空比
上斜波	100% 对称
三角波	50% 对称
下斜波	0% 对称

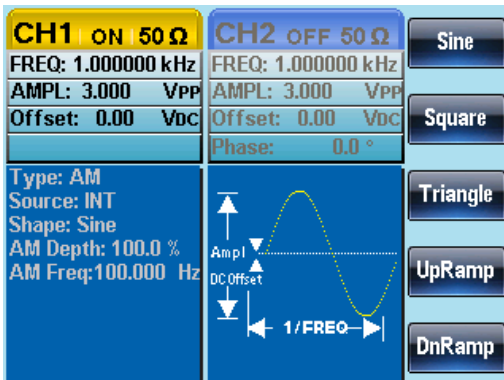

### AM 频率

调制波形的频率(AM 频率)可在 2mHz~20kHz 范围内设置。

面板操作

1. 按 MOD 键 
2. 按 F1 (AM)  
3. 按 F3 (AM Freq)  
4. 在波形显示区域内的 AM Freq 参数变亮

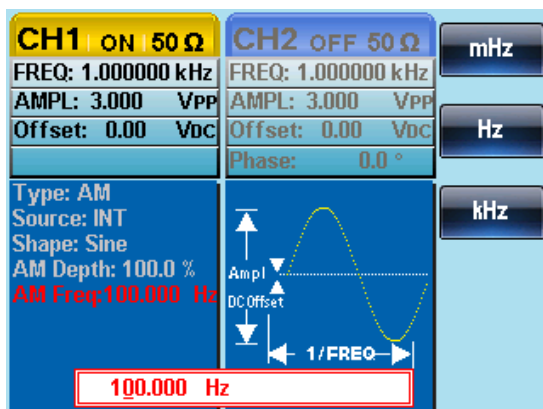

5. 使用方向键和可调旋钮或数字键盘输入 AM 频率

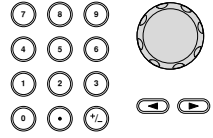

6. 按 F1~F3 选择频率范围

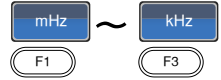

---

范围	调制频率	2mHz~20kHz
	默认频率	100Hz

## 调制深度

调制深度为未调制载波幅值与调制波形最小幅值偏差的比值(百分比显示)。换句话说，调制深度就是调制波形与载波波形的最大幅值之比。

面板操作

1. 按 MOD 键



2. 按 F1 (AM)



3. 按 F2 (Depth)



4. 在波形显示区域内的 AM Depth 参数变亮

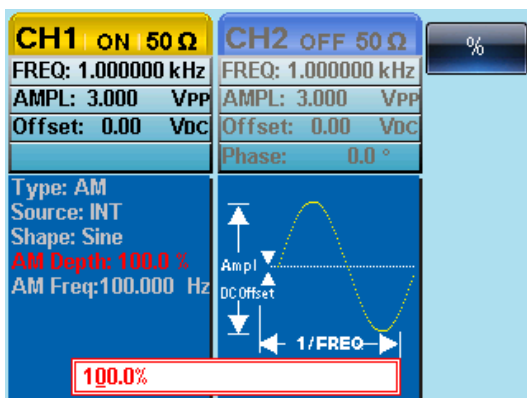

5. 使用方向键和可调旋钮或数字键盘输入 AM 深度

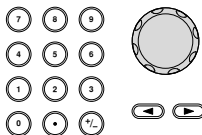

6. 按 F1 (%)选择%单位



范围

深度

0%~120%

默认深度

100%

**注意** 即使调制深度大于 100%，输出也不能超过 $\pm 5V_{Peak}$  (10k $\Omega$  负载)。

如果选择外部调制源，那么调制深度将被后面板的 MOD INPUT 端子限制在 $\pm 5V$ 。例如，如果调制深度设置为 100%，那么最大幅值为+5V，最小幅值为-5V。

## 选择 (AM) 调制源

信号发生器将接受用于 AM 调制的内部或外部源，默认为内部源。

面板操作

1. 按 MOD 键



2. 按 F1 (AM)



3. 按 F1 (Source)



4. 按 F1 (INT) 或 F2 (EXT) 选择调制源

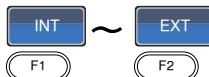

5. 按 Return 返回上层菜单



外部源

从后面板的 MOD INPUT 端子接收外部调制信号。

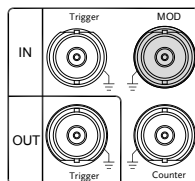

**注意**

如果选择外部调制源，那么调制深度将被后面板的 MOD INPUT 端子限制在 $\pm 5V$ 。例如，如果调制深度设置为 100%，那么最大幅值为+5V，最小幅值为-5V。

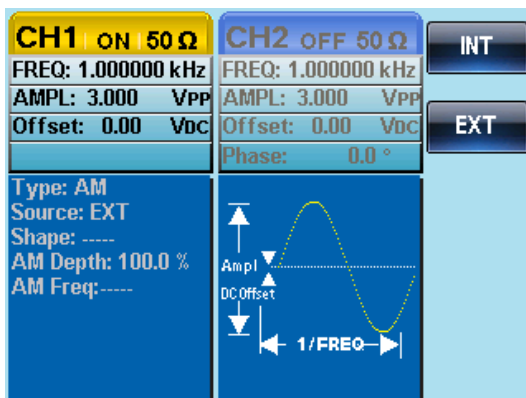



## 频率调制(FM)

FM 波形由载波和调制波组成。载波的瞬时频率随调制波形的幅值而变化。当使用 AFG-2225 时，无论何时只允许开启一种调制模式。

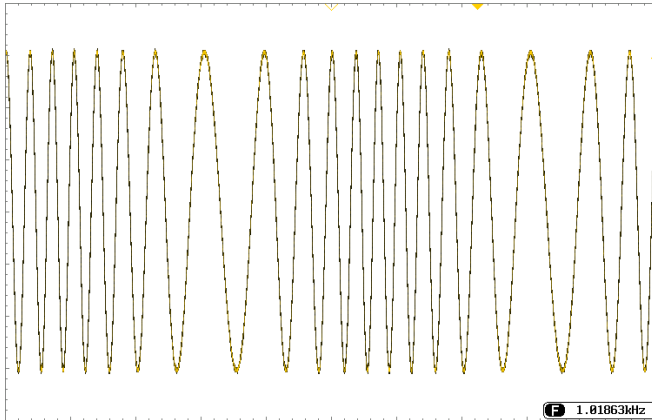

## 选择频率调制(FM)

选择 FM 后，调制波形由载波频率、输出幅值和偏置电压决定。

面板操作

1. 按 MOD 键



2. 按 F2 (FM)

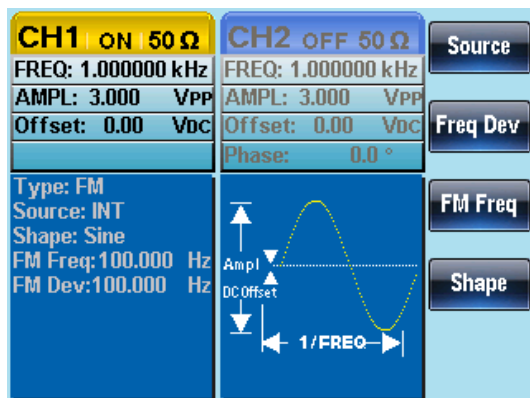

## FM 载波波形

背景

默认为正弦波。噪声波和脉冲波不能用作载波。

面板操作

1. 按 Waveform 键



2. 按 F1~F4 选择载波波形



范围

载波波形

正弦波, 方波, 斜波

## FM 载波频率

使用 AFG-2225 时，载波频率必须大于等于频率偏移。如果频率偏移设置大于载波频率，信号发生器会自动将偏移调整到当前载波频率所允许的最大值。载波最大频率与所选波形有关。

面板操作

1. 按 **FREQ/Rate** 键选择载波频率



2. 在参数窗口内的 **FREQ** 参数变亮

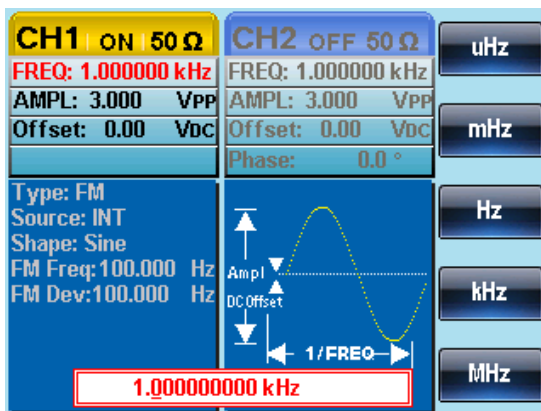

3. 使用方向键和可调旋钮或数字键盘输入载波频率

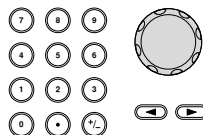

4. 按 **F1~F5** 选择频率单位

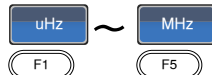

范围

载波波形

载波频率

正弦波

1 $\mu$ Hz~25MHz

方波

1 $\mu$ Hz~15MHz

斜波









1 $\mu$ Hz~1MHz

默认频率

1kHz

## FM 波形

信号发生器接受内部和外部调制源。AFG-2225 的内部调制波形包括正弦波、方波、三角波、正和负斜波(UpRamp, DnRamp)。默认波形为正弦波。

- |    |                    |  |
|----|--------------------|--|
| 背景 | 1. 选择 MOD          |   |
|    | 2. 按 F2 (FM)       |    |
|    | 3. 按 F4 (Shape)    |    |
|    | 4. 按 F1 ~ F5 选择波形  |  ~ <br>  |
|    | 5. 按 Return 返回上层菜单 |   |

范围	方波	50% 占空比
	上斜波	100% 对称
	三角波	50% 对称
	下斜波	0% 对称

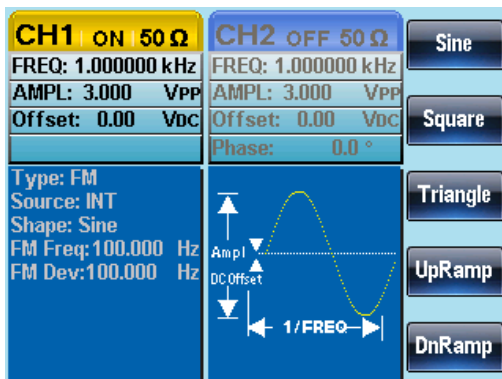

## FM 频率

调制波形的频率(FM 频率)可在 2mHz~20kHz 范围内设置。

面板操作

1. 按 MOD 键 
2. 按 F2 (FM) 
3. 按 F3 (FM Freq) 
4. 在波形显示区域内的 FM Freq 参数变亮

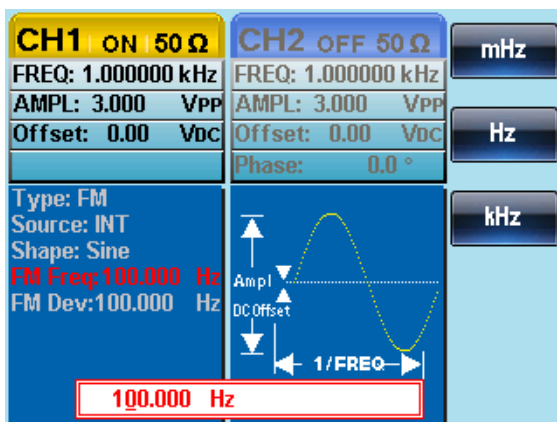

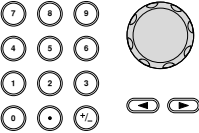
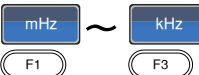
5. 使用方向键和可调旋钮或数字键盘输入 FM 频率 
6. 按 F1~F3 选择频率单位 

范围	调制频率	2mHz~20kHz
	默认频率	100Hz

## 频率偏移

频率偏移是载波与调制波的最大频率偏差。

面板操作

1. 按 MOD 键



2. 按 F2 (FM)



3. 按 F2 (Freq Dev)



4. 在波形显示区域内的 Freq Dev 参数变亮

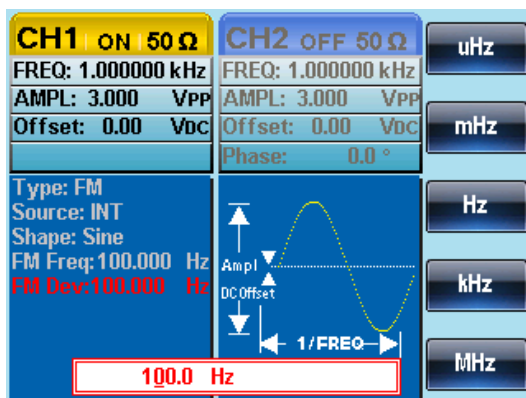

5. 使用方向键和可调旋钮或数字键盘输入频率偏移

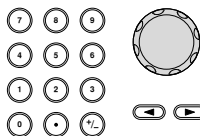

6. 按 F1~ F5 选择频率单位

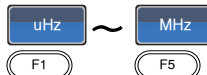

范围

频率偏移











DC~25MHz  
DC~15MHz(方波)  
DC~1MHz(斜波)

默认深度

100Hz

## 选择(FM)调制源

信号发生器将接受用于 FM 调制的内部或外部源，默认为内部源。

面板操作	1. 按 MOD 键	
	2. 按 F2 (FM)	 
	3. 按 F1 (Source)	 
	4. 按 F1 (Internal)或 F2 (External)选择调制源	    
	5. 按 Return 返回上层菜单	

外部调制源 从后面板的 MOD INPUT 端子接收外部调制信号。

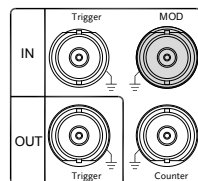

### 注意

如果选择外部调制源，那么频偏将由后面板 MOD INPUT 端子上的 $\pm 5V$  信号电压控制。频偏与调制信号电平成比例。例如，如果调制电压为+5V，那么频偏将等于设置的频偏。外部信号电平越低，偏移就越小；而负信号电平将会使频偏频率降至载波频率之下。

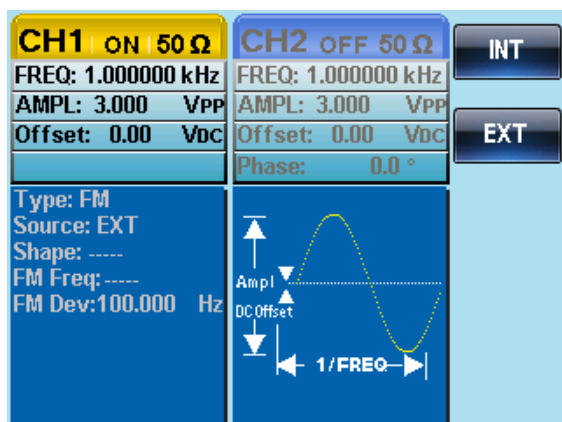



## 频移键控(FSK)调制

FSK 调制在两个预设频率(载波频率和跳跃频率)之间交替输出频率。内部频率发生器或后面板 Trigger INPUT 端子上的信号电平决定交替频率。

信号发生器每次只允许启用一种调制模式。当开启 FSK 调制时，其它调制模式将关闭。在开启 Sweep 和脉冲串时不允许使用 FSK 调制。在启用 FSK 时，将关闭 Sweep 或脉冲串模式。

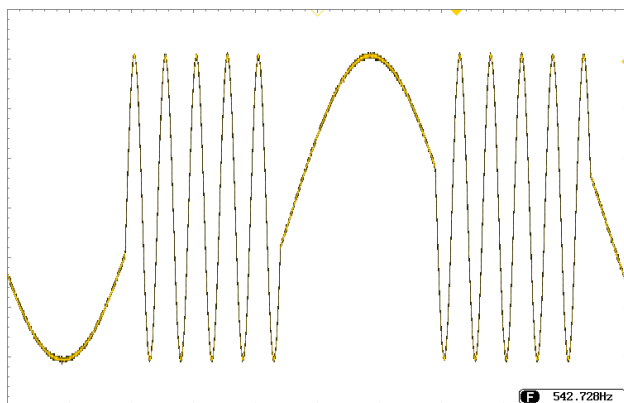

## 选择 FSK 调制

当使用 FSK 模式时, 输出波形使用默认载波频率、幅值和偏置电压。

面板操作

1. 按 MOD 键



2. 按 F3 (FSK)

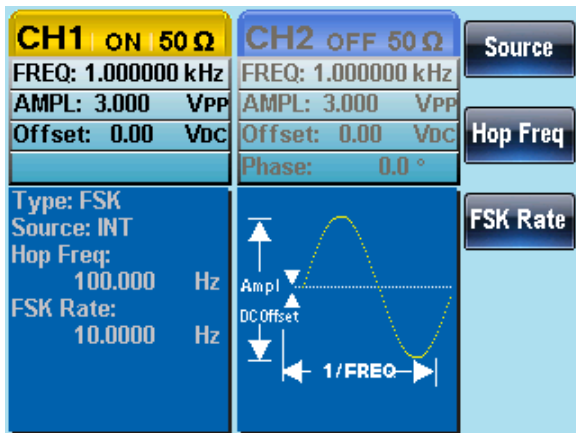

## FSK 载波波形

背景

默认为正弦波。噪声波不能用作载波。

面板操作

1. 按 Waveform 键



2. 按 F1~F4 选择载波波形



范围

载波波形

正弦波, 方波, 脉冲波, 斜波

## FSK 载波频率

最大载波频率与载波波形有关，默认为 1kHz。选择外部源时，Trigger INPUT 信号的电压电平控制输出频率。当 Trigger INPUT 信号为逻辑低电平时，输出载波频率；当信号为逻辑高电平时，输出跳跃频率。

### 面板操作

1. 按 **FREQ/Rate** 键选择载波频率 

2. 在参数窗口内的 **FREQ** 参数变亮



3. 使用方向键和可调旋钮或数字键盘输入载波频率

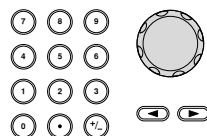

4. 按 **F1~F5** 选择 FSK 频率单位

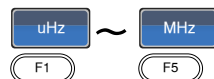

范围	载波波形	载波频率
	正弦波	1 $\mu$ Hz~25MHz
	方波	1 $\mu$ Hz~15MHz
	斜波	1 $\mu$ Hz~1MHz
	脉冲波	500 $\mu$ Hz~15MHz
	默认频率	1kHz

## FSK 跳跃频率

默认跳跃频率为 100 Hz。内部调制波是占空比为 50% 的方波。选择外部源时，Trigger INPUT 信号的电压电平控制输出频率。当 Trigger INPUT 信号为逻辑低电平时，输出载波频率；当信号为逻辑高电平时，输出跳跃频率。

面板操作

1. 按 MOD 键



2. 按 F3 (FSK)



3. 按 F2 (Hop Freq)



4. 在波形显示区域内的 Hop Freq 参数变亮

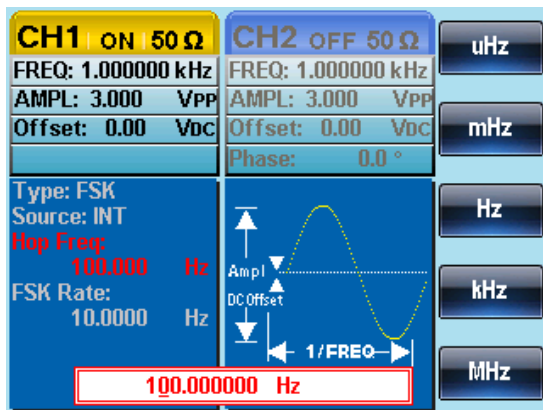

5. 使用方向键和可调旋钮或数字键盘输入跳跃频率

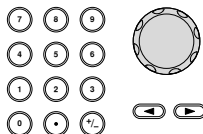





6. 按 F1~F5 选择频率单位



范围	波形	载波频率
	正弦波	1 $\mu$ Hz~25MHz
	方波	1 $\mu$ Hz~15MHz
	斜波	1 $\mu$ Hz~1MHz
	脉冲波	500 $\mu$ Hz~15MHz
	默认频率	100Hz

### FSK 频率

FSK 频率是决定输出载波频率或是跳跃频率的频率值。FSK 频率仅用于内部 FSK 调制源。

- 面板操作
1. 按 MOD 键 
  2. 按 F3 (FSK)  
  3. 按 F3 (FSK Rate)  
  4. 在波形显示区域内的 FSK Rate 参数变亮

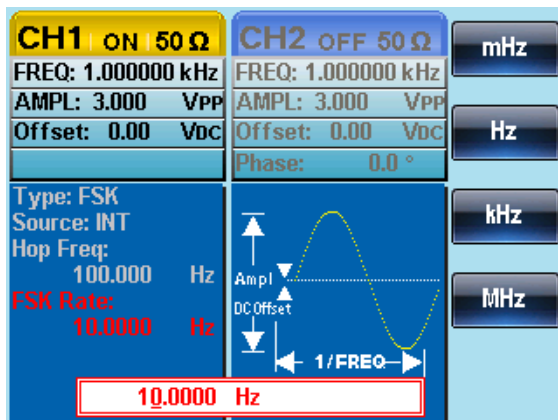

5. 使用方向键和可调旋钮或数字  
键盘输入 FSK 频率

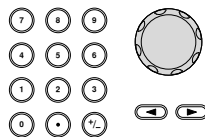

6. 按 F1~F4 选择频率单位

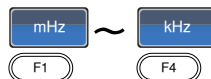











范围	FSK 频率	2mHz~100kHz
	默认	10Hz

注意 如果选择外部调制源，FSK 频率设置关闭。

## FSK 调制源

AFG-2225 接受内部和外部 FSK 调制源，默认为内部源。当选择内部 FSK 源时，使用 FSK Rate 功能设置 FSK 频率。当选择外部源时，FSK 频率与后面板 Trigger INPUT 信号的频率一致。

- |      |  |  |
|------|--|--|
| 面板操作 | 1. 按 MOD 键                                     |   |
|      | 2. 按 F3 (FSK)                                  |    |
|      | 3. 按 F1 (Source)                               |    |
|      | 4. 按 F1 (Internal)或 F2<br>(External)选择 FSK 调制源 |  <br>  |
|      | 5. 按 Return 返回上层菜单                             |   |

注意

Trigger INPUT 端子不能设置边沿极性。

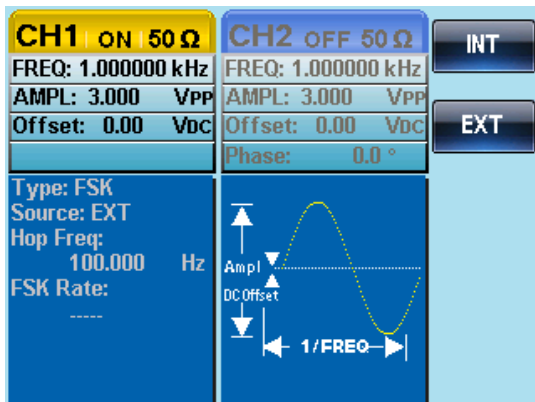

## 相位调制 (PM)

载波的相位偏移值与调制波形的变化成比例。

每次仅可以使用一种调制模式。如果开启 PM，任何其它调制模式将关闭。同样的，脉冲串和 Sweep 模式不能与 PM 同时使用，二者在开启 PM 时关闭。

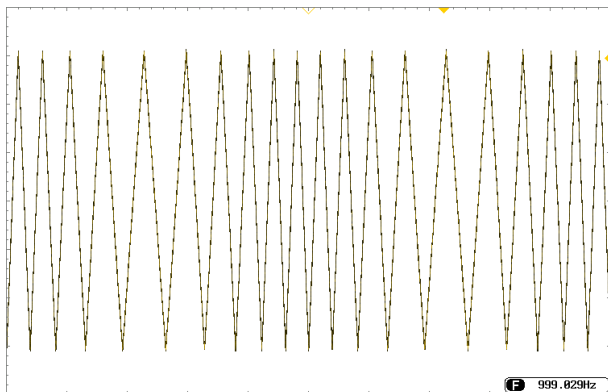



## 选择相位调制(PM)

当选择相位调制时，载波的中心频率，调制波的幅度，及输入输出电压，都必须经过设定。

面板操作

1. 按 MOD 键



2. 按 F4 (PM)

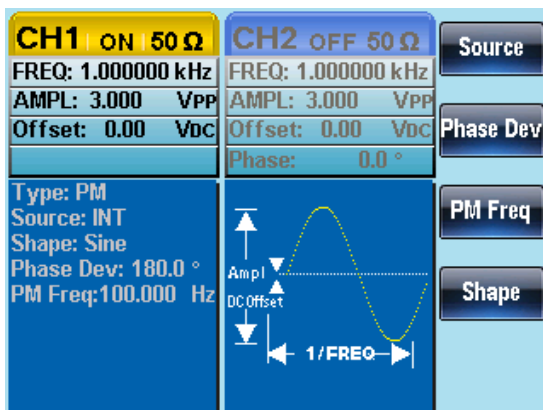

## PM 载波波形

**背景** PM 载波默认为正弦波。噪声波和脉冲波不能用于相位调制。

**面板操作**

1. 按 Waveform 键



2. 按 F1 ~ F4 选择波形

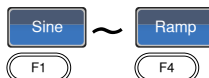

**范围**

载波波形

正弦波, 方波, 斜波

## PM 载波频率

最大载波频率与载波波形的选择有关。默认载波频率为 1kHz。

**面板操作**

1. 按 **FREQ/Rate** 键选择载波频率



2. 在参数窗口内的 **FREQ** 参数变亮



3. 使用方向键和可调旋钮或数字键盘输入载波频率

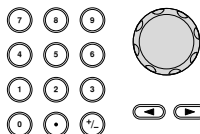

4. 按 F1~F5 选择频率单位

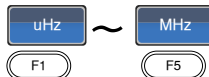

**范围**

载波波形

载波频率

正弦波	1 $\mu$ Hz~25MHz
方波	1 $\mu$ Hz~15MHz
斜波	1 $\mu$ Hz~1MHz
默认频率	1 kHz

## PM 波形

信号发生器能接受内部和外部调制源。内部调制波形包括正弦波、方波、三角波、正和负斜波(UpRamp, DnRamp)，默认为正弦波。

### 面板操作

1. 按 MOD 键 
2. 按 F4 (PM)  
3. 按 F4 (Shape)  
4. 按 F1~F5 选择波形    
5. 按 Return 返回上层菜单 

### 范围

波形	
方波	50% 占空比
上斜波	100% 对称
三角波	50% 对称
下斜波	0% 对称

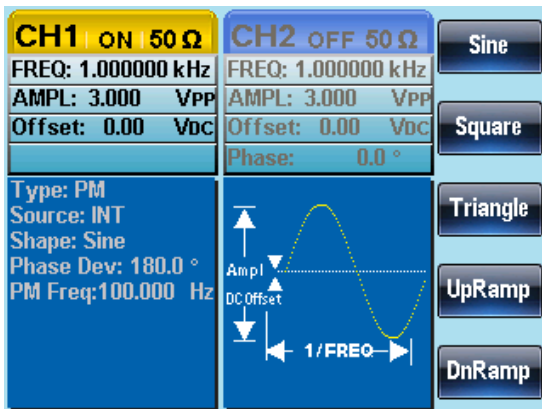

### PM 频率

调制波形的频率(PM 频率)可在 2mHz~20kHz 范围内设置。

面板操作

1. 按 MOD 键 MOD
2. 按 F4 (PM) PM F4
3. 按 F3 (PM Freq) PM Freq F3
4. 在波形显示区域内的 PM Freq 参数变亮

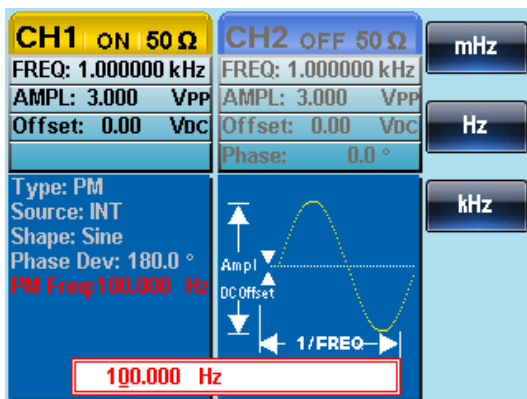

5. 使用方向键和可调旋钮或数字键盘输入 PM 频率

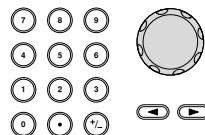

6. 按 F1~F3 选择频率单位

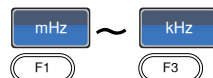

范围	调制频率	2mHz~20kHz
	默认频率	100Hz

## 相位偏移

最大相位偏移与载波频率和调制波形有关。

面板操作

1. 按 MOD 键



2. 按 F4 (PM)



3. 按 F2 (Phase Dev)



4. 在波形显示区域内的 Phase Dev 参数变亮

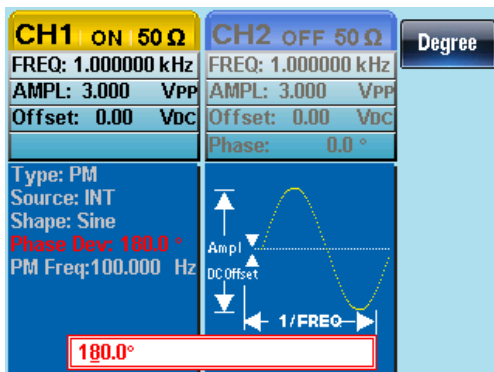

5. 使用方向键和可调旋钮或数字键盘输入相位偏移

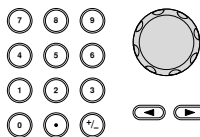

6. 按 F1 选择相位单位



范围

相位偏移

0~360°

默认相位

180°

## 选择 PM 调制源

信号发生器将接受用于相位(PM)调制的内部或外部调制源，默认为内部源。

- |      |                              |  |
|------|------------------------------|--|
| 面板操作 | 1. 按 MOD 键                   |   |
|      | 2. 按 F4 (PM)                 |    |
|      | 3. 按 F1 (Source)             |    |
|      | 4. 按 F1 (INT)或 F2 (EXT)选择调制源 |  ~ <br>  |
|      | 5. 按 Return 返回上层菜单           |   |

外部调制源 从后面板的 MOD INPUT 端子接收外部调制信号。

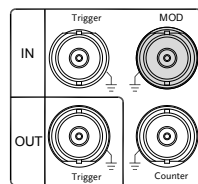

### 注意

如果选择外部调制源，那么相位偏移将由后面板 MOD INPUT 端子上的 $\pm 5V$  信号电压控制。例如，如果调制电压为 $+5V$ ，那么相位偏移将等于设定的相位偏移。如果调制电压小于 $+5V$ ，那么相位偏移将小于设定值。

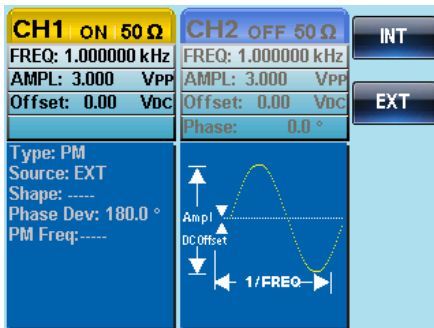



## SUM 调制

Sum 调制用于在载波上加入一个调制信号，如在载波上加入噪声。以载波幅值的百分比增大调制信号。

如果开启 SUM，其它任何调制模式都将关闭。同样的，不允许脉冲串和 Sweep 模式与 SUM 同时使用。若使用 SUM，将关闭脉冲串和 Sweep 模式。

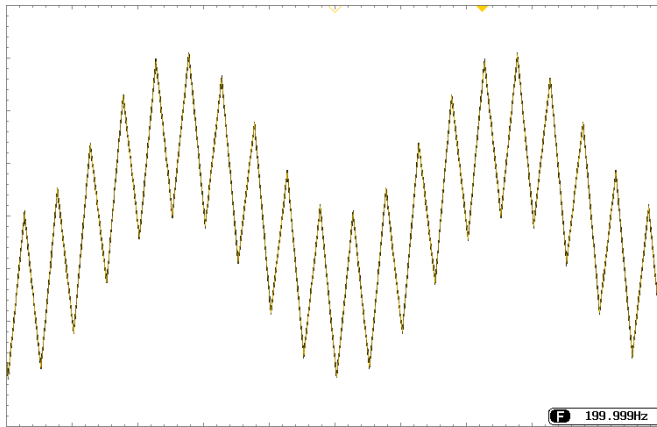

## 选择 SUM 调制

对于 SUM 调制，载波决定调制波的幅值和偏置电压。

面板操作

1. 按 MOD 键



2. 按 F5 (SUM)

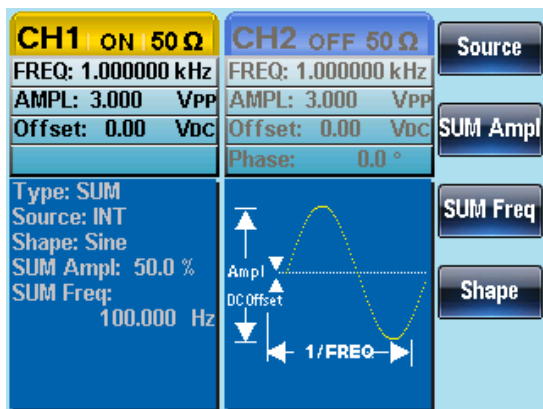

## SUM 载波波形

背景

SUM 载波默认为正弦波。

面板操作

1. 按 Waveform 键



2. 按 F1~F5 选择载波

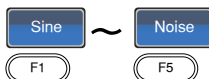

范围

载波波形

正弦波，方波，脉冲波，斜波和噪声波

## SUM 载波频率

最大载波频率与所选载波波形有关，默认 1kHz。

面板操作

1. 按 **FREQ/Rate** 键选择载波频率 
2. 在参数窗口内的 **FREQ** 参数变亮



3. 使用方向键和可调旋钮或数字键盘输入频率

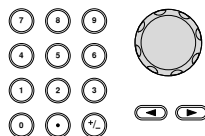



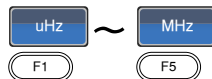







4. 按 **F1 ~ F5** 选择频率单位



范围	载波波形	载波频率
	正弦波	1 $\mu$ Hz~25MH
	方波	1 $\mu$ Hz~25MHz
	脉冲波	500 $\mu$ Hz~25MHz
	斜波	1 $\mu$ Hz~1MHz
	默认频率	1 kHz

## SUM 波形

信号发生器接受内部或外部调制源。AFG-2225 的内部调制源包括正弦波、方波、三角波、正斜波和负斜波，默认为正弦波。

- |      |                    |  |
|------|--------------------|--|
| 面板操作 | 1. 按 MOD 键         |   |
|      | 2. 按 F5 (SUM)      |    |
|      | 3. 按 F4 (Shape)    |    |
|      | 4. 按 F1~F5 选择调制源波形 |  ~ <br>  |
|      | 5. 按 Return 返回上层菜单 |   |

范围	方波	50% 占空比
	上斜波	100% 对称
	三角波	50% 对称
	下斜波	0% 对称

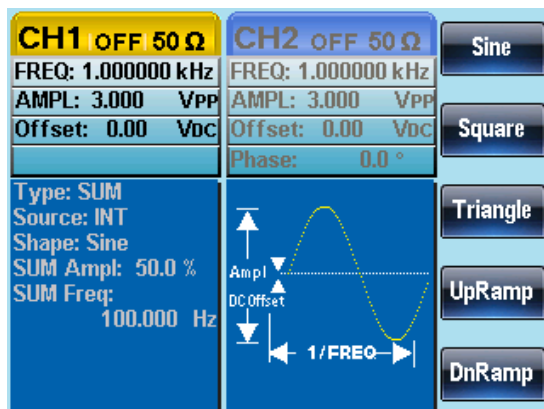

## 调制波形频率

调制波频率(SUM 频率)从 2mHz~20kHz 可设。

面板操作

1. 按 MOD 键



2. 按 F5 (SUM)



3. 按 F3 (SUM Freq)



4. 在波形显示区域内的 SUM Freq 参数变亮

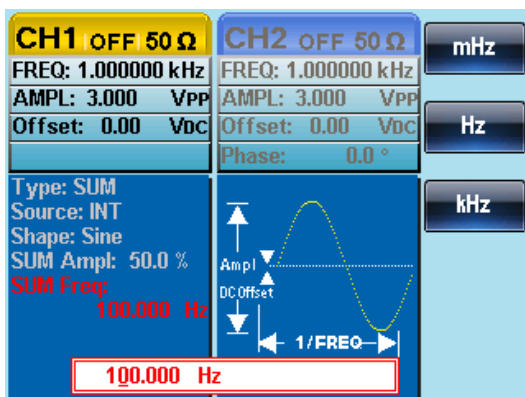

5. 使用方向键和可调旋钮或数字键盘输入 SUM 频率

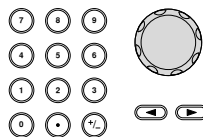

6. 按 F1~F3 选择频率单位

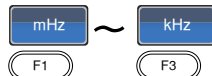

范围

调制范围

2mHz~20kHz

默认频率

100Hz

## SUM 幅值

SUM 的幅值，为加到载波上的比例，（相当于载波的百分比）

面板操作

1. 按 MOD 键



2. 按 F5 (SUM)



3. 按 F2 (SUM Ampl)



4. 在波形显示区域内的 SUM Ampl 参数变亮

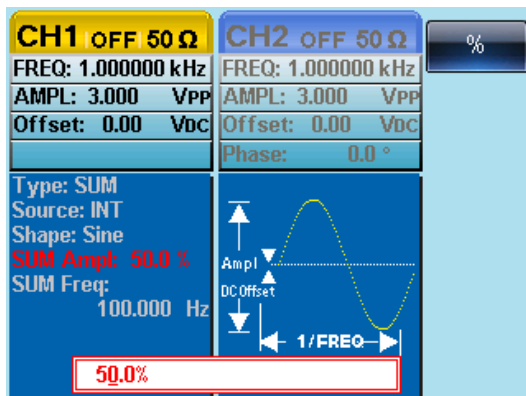

5. 使用方向键和可调旋钮或数字键盘输入 SUM 幅值

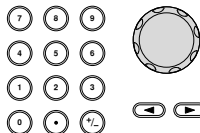

6. 按 F1 选择百分比单位



范围	Sum 幅值	0~100%
	默认幅值	50%

## 选择 SUM 调制源

信号发生器将接受用于 SUM 幅值调制的内部或外部源，默认为内部源。

### 面板操作

1. 按 MOD 键 
2. 按 F5 (SUM)  
3. 按 F1 (Source)  
4. 按 F1 (INT)或 F2 (EXT)选择调制源    
5. 按 Return 返回上层菜单 

### 外部调制源

从后面板的 MOD INPUT 端子接收外部调制信号。

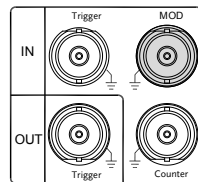

### 注意

如果选择外部调制源，那么 SUM 幅值将由后面板 MOD INPUT 端子上的 $\pm 5V$ 信号电压控制。例如，如果 SUM 幅值设为 0%，那么最大幅值(载波的 100%)将限定在+5V，最小幅值(载波的 0%)限定在-5V。

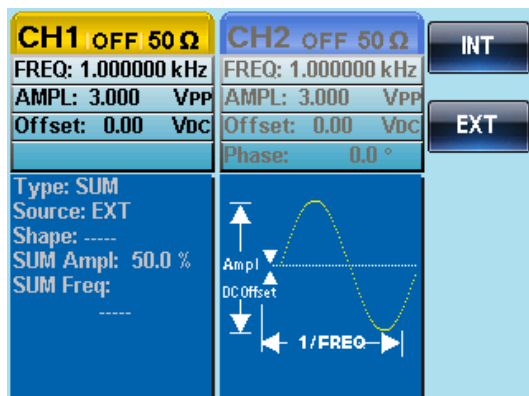



## 频率扫描

除噪声波和脉冲波外，信号发生器可以对正弦波、方波或斜波产生一个扫频。在开启 Sweep 模式时，关闭脉冲串或其它调制模式。

在 Sweep 模式下，信号发生器以指定步进从起始频率到停止频率扫描。它够以线性或对数间隔由高频向低频扫描，或者由低频向高频扫描。如果使用手动或外部调制源，信号发生器可用于输出一个单次扫描。

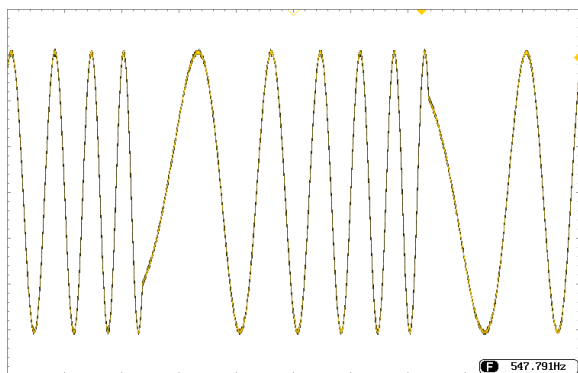

## 选择 Sweep 模式

按 Sweep 按钮，进入扫描模式。如果不预先设置，输出幅值、偏移和频率使用默认值。



## 设置起始和停止频率

起始频率和停止频率定义扫描上限和下限。信号发生器从起始频率开始，一直扫描到停止频率，然后又复位回起始频率。在整个扫描范围内，相位连续(1μHz-25MHz)。

面板操作

1. 按 SWEEP 键



2. 按 F3 (Start)或 F4 (Stop)选择起始或停止频率

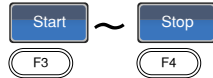

3. 在波形显示区域内的 Start 或 Stop 参数变亮

起始

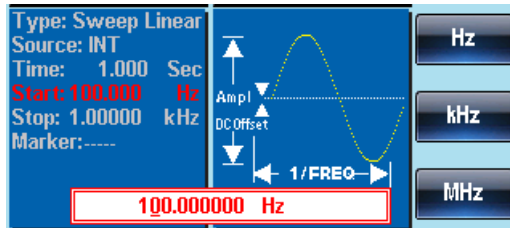

停止

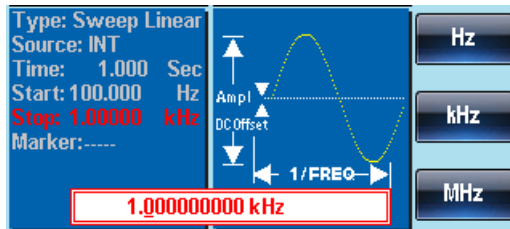

4. 使用方向键和可调旋钮或数字键盘输入 Stop/Start 频率

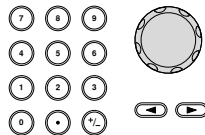

5. 按 F1~F5 选择 Start/Stop 频率单位

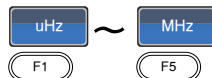

范围	扫描范围	1μHz~25MHz (正弦波)
		1μHz~1MHz (斜波)
		1μHz~15MHz (方波)
	Start – 默认	100Hz
	Stop – 默认	1kHz

注意

从低频到高频扫描，设置起始频率 < 停止频率。

当标记输出开启时，在标记频率处输出一个由低电平上升到高电平的 TTL 信号。

从高频到低频扫描，设置起始频率 > 停止频率。

当标记输出开启时，在标记频率处输出一个由高电平下降到低电平的 TTL 信号。

关闭标记输出时，同步输出信号也关闭。同步信号的频率跟扫描时间相等。

同步输出信号从后面板的触发输出端口输出。

### 中心频率和跨距

中心频率和跨距的设置决定扫描的上限和下限(起始频率/停止频率)。

面板操作

1. 按 SWEEP 键



2. 按 F5 (More)



3. 按 F2 (Span)或 F3 (Center)选择跨距或中心频率

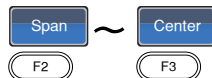

4. 在波形显示区域内的 Span 或 Center 参数变亮

跨距

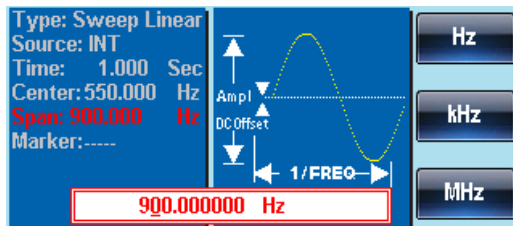

中心

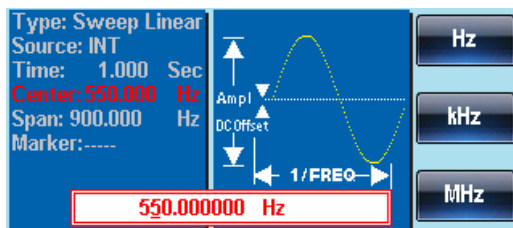

5. 使用方向键和可调旋钮或数字键盘输入 Span/Center 频率

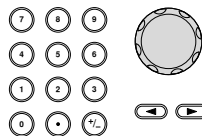

6. 按 F1~F5 选择 Start/Stop 频率单位

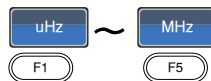

范围

中心频率

1μHz~25MHz (正弦波)

1μHz~1MHz (斜波)

1μHz~15MHz (方波)

跨距

DC~+/-25MHz

(正弦波)

DC ~+/-1MHz (斜波)

1μHz~+/-15MHz (方波)

默认中心频率

550Hz

默认跨距

900Hz

注意 从低频到高频扫描，设置正频率跨距。  
从高频到低频扫描，设置负频率跨距。

## Sweep 模式

Sweep 模式可选择线性或对数扫描，默认线性扫描。

面板操作

1. 按 SWEEP 键



2. 按 F2 (Type)



3. 按 F1 (Linear)或 F2 (Log)选择线性或对数扫描

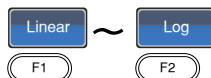

4. 按 Return 返回上层菜单

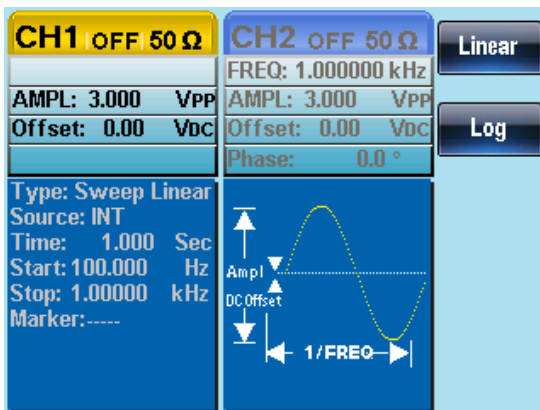

## Sweep 时间

从起始频率到截止频率完成一次扫描所需的时间称为扫描时间。信号发生器自动限定扫描的离散频率点，该数目与扫描长度有关。

面板操作

1. 按 SWEEP 键 
2. 按 F5 (More)  
3. 按 F1 (SWP Time)  
4. 在波形显示区域内的 Time 参数变亮

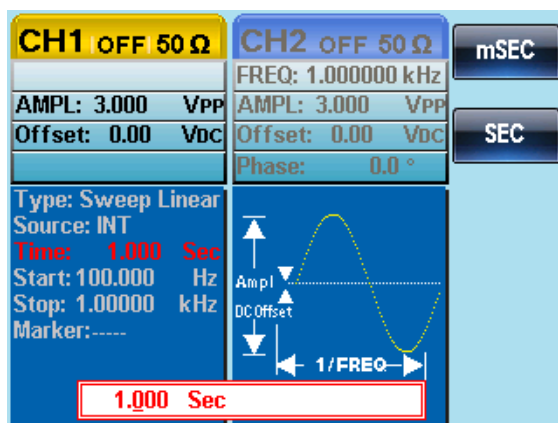

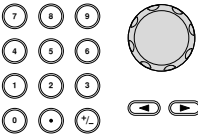
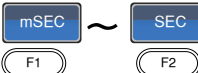
5. 使用方向键和可调旋钮或数字键盘输入 Sweep 时间 
6. 按 F1~F2 选择时间单位 

范围	扫描时间	1ms ~ 500s
	默认时间	1s

## 标记频率

标记信号由低电平变为高电平时的频率称为标记频率(或者由高电平变为低电平)。后面板 Trigger OUT 端子输出标记信号，默认 550 Hz。

### 面板操作

1. 按 SWEEP 键 
2. 按 F5 (More)  
3. 按 F4 (Marker)  
4. 按 F2 (ON/OFF)开启/关闭标记  
5. 按 F1 (Freq)选择标记频率  
6. 在波形显示区域内的 Marker 参数变亮

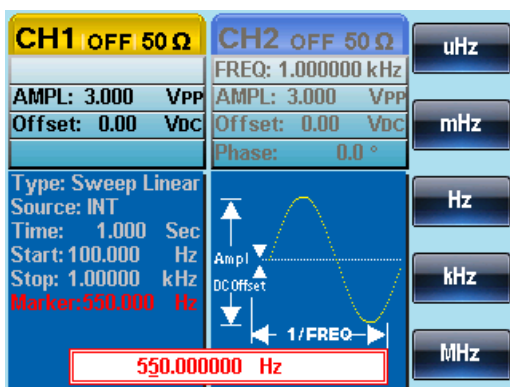

7. 使用方向键和可调旋钮或数字键盘输入频率

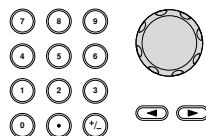

8. 按 F1~F5 选择频率单位

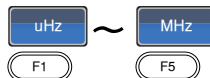

范围	频率	1μHz~25MHz (正弦波) 1μHz~1MHz (斜波)
		1μHz~15MHz (方波)
	默认	550Hz

**注意** 标记频率必须设置在起始频率和停止频率之间。如无设置，标记频率将等于起始频率和停止频率的平均值。

开启扫描模式后，标记模式将忽略同步模式的设置。

### Sweep 触发源

Sweep 模式下，信号发生器在收到触发信号时输出一个扫描。扫描输出完成后，信号发生器输出起始频率，并等待下一次触发。默认内部触发源。

面板操作

1. 按 SWEEP 键



2. 按 F1 (Source)



3. 按 F1 (Internal), F2 (External) 或 F3 (Manual) 选择触发源

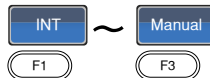

4. 按 Return 返回上层菜单





注意 选择内部触发源时，信号发生器输出一个连续的扫描，其频率由扫描时间决定。

选择外部触发源时，每收到一个从后面板 Trigger IN 端子的触发脉冲(TTL)，信号发生器就输出一个扫描。

触发周期必须大于或等于扫描时间+1ms。

5. 如果选择手动触发, 按 F1 (Trigger)执行手动扫描

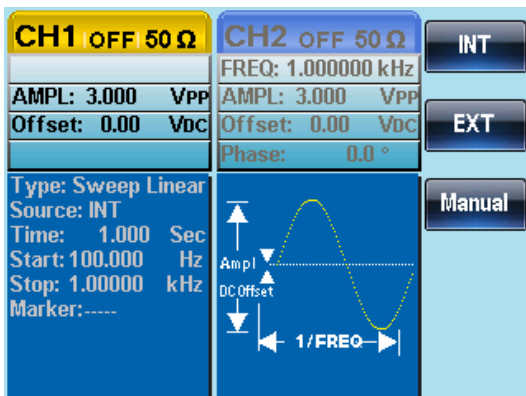

## 脉冲串模式

信号发生器能创建一个具有指定循环数的波形脉冲串。脉冲串模式支持正弦波、Arb、方波和斜波。

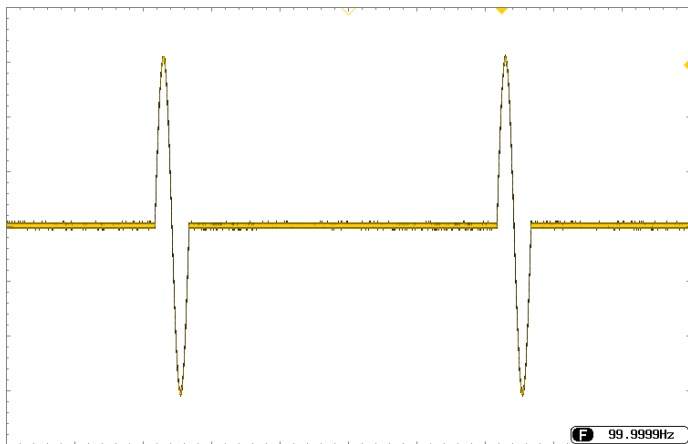

## 选择脉冲串模式

选择脉冲串模式后，将自动关闭任何调制或扫描模式。如果无预设置，输出幅值、偏移和频率启用默认值。



## 脉冲串模式

触发(N次循环模式)或门控模式可以设置脉冲串模式。在N次循环/触发模式下，信号发生器每接收一次触发都将输出一个指定循环次数的波形(脉冲串)。执行完成后，信号发生器将停止并等待下一次触发。N次循环为默认脉冲串模式。内部或外部触发均可使用。

相比指定循环次数，门控模式使用外部触发开启或关闭输出。当 Trigger INPUT 信号为高电平时，波形持续输出。当 Trigger INPUT 信号为低电平时，信号发生器在输出最后一个完整波形后停止。输出电压电平仍与脉冲串波形的起始相位相同。

脉冲串模式	脉冲串计数	脉冲串周期	相位	触发源
Triggered (Int)	可用	可用	可用	立即
Triggered (Ext)	可用	不可用	可用	EXT, Bus
Gated pulse (Ext)	不可用	不可用	可用	不可用

门控模式下，脉冲串计数、脉冲串周期和触发源关闭。如果此时输入触发信号，将不会产生任何效果，也不会提示错误。

面板操作

1. 按 Burst 键



2. 选择 N Cycle (F1)或 Gate (F2)





## 脉冲串频率

在 N 次循环和门控模式下，波形频率定义了脉冲串波形的重复率。在 N 次循环模式下，以指定循环次数输出波形。在门控模式下，当触发信号为高电平时输出波形频率。脉冲串模式支持正弦波、Arb、方波或斜波。

### 面板操作

1. 按 **FREQ/Rate** 键



2. 在参数窗口内的 **FREQ** 参数变亮



3. 使用方向键和可调旋钮或数字键盘输入频率

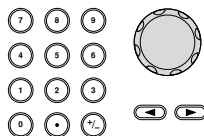

4. 按 **F1~F5** 选择频率单位

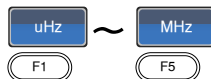

范围	频率— Sine	1uHz~15MHz
	频率 – Ramp	1uHz~1MHz
	频率_ Square	1kHz_15MHz

**注意** 波形频率不同于脉冲串周期。脉冲串周期指 N 次循环模式下脉冲串波形之间的时间间隔。



## 脉冲串循环/计数

脉冲串循环(脉冲串计数)是指脉冲串波形的循环次数,仅用于 N Cycle 模式(内部,外部或手动触发)。默认 1 次循环。

面板操作

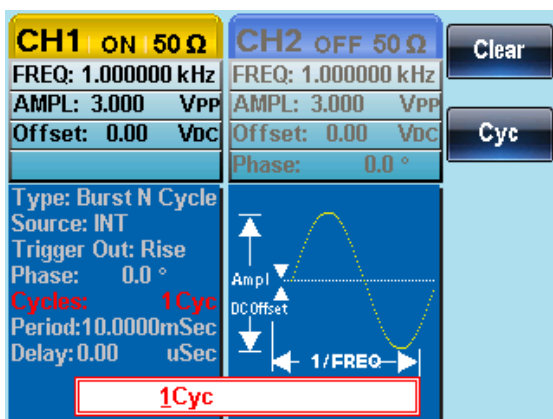
1. 按 Burst 键 
2. 按 F1 (N Cycle)  
3. 按 F1 (Cycles)  
4. 在波形显示区域内的 Cycles 参数变亮

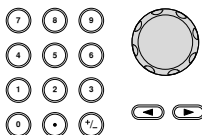

5. 使用方向键和可调旋钮或数字键盘输入循环次数 
6. 按 F2 选择 Cyc 单位  

范围

Cycles

1~65535

---

注意 选择内部触发源时，持续输出循环数。脉冲串周期决定脉冲串频率和各脉冲串之间的时间间隔。





脉冲串循环必须小于脉冲串周期和波形频率的乘积。

脉冲串循环 < (脉冲串周期 x 波形频率)

如果脉冲串循环超出上述限制，信号发生器将自动增大脉冲串周期，以满足上述条件。

选择门控脉冲串模式时，忽略脉冲串循环。如果从远程接口更改循环，信号发生器将记录新的脉冲串循环，并在下次使用。

## 无限脉冲串计数



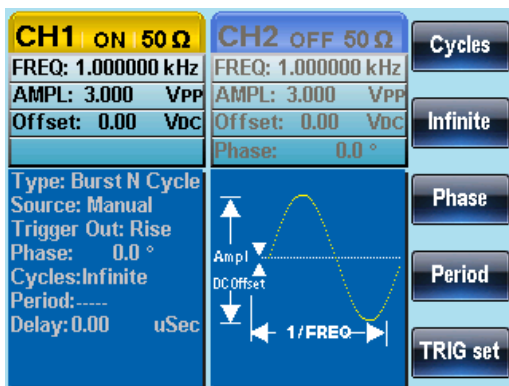

- |      |                    |   |
|------|--------------------|---|
| 面板操作 | 1. 按 Burst 键       |    |
|      | 2. 按 F1 (N Cycle)  |   |
|      | 3. 按 F2 (Infinite) |   |

注意 无限脉冲串仅用在手动触发模式。



## 脉冲串周期

从一个脉冲串的开始至下一个脉冲串的开始所经历的时间称为脉冲串周期。仅用于内部触发脉冲串模式。

- |      |                   |   |
|------|-------------------|---|
| 面板操作 | 1. 按 Burst 键      |    |
|      | 2. 按 F1 (N Cycle) |   |
|      | 3. 按 F4 (Period)  |   |

4. 在波形显示区域内的 Period 参数变亮

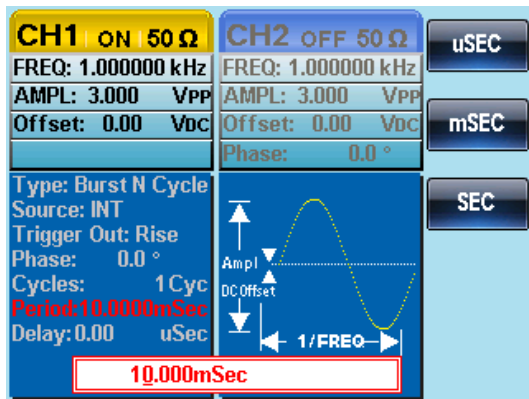

5. 使用方向键和可调旋钮或数字键盘输入周期

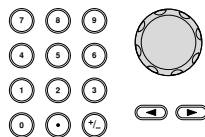

6. 按 F1~F3 选择周期单位



范围	周期	1ms~500s
	默认	10ms

注意 脉冲串周期仅用于内部触发。当使用门控脉冲串模式或外部和手动触发时，关闭脉冲串周期设置。

脉冲串周期一定要够长，且满足如下条件：

脉冲串周期 > 脉冲串计数 / 波形频率 + 200ns





## 脉冲串相位

脉冲串波形的起始相位称为脉冲串相位，默认 0°。

面板操作

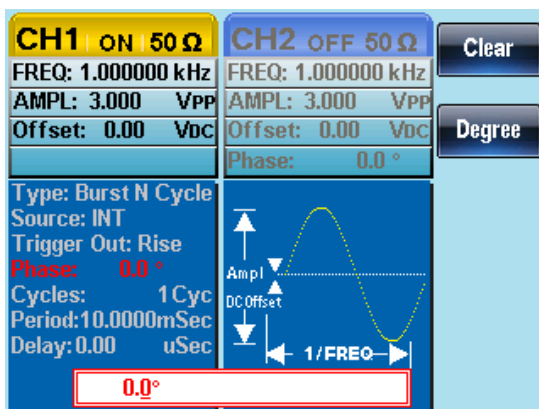
1. 按 Burst 键 
2. 按 F1 (N Cycle)  
3. 按 F3 (Phase)  
4. 在波形显示区域内的 Phase 参数变亮

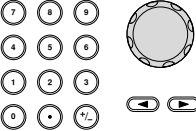

5. 使用方向键和可调旋钮或数字键盘输入相位 
6. 按 F2 (Degree)选择相位单位  

范围	相位	-360° ~ +360°
	默认	0°

**注意** 当使用正弦波、方波、三角波或斜波时， $0^\circ$ 与波形 0V 点相对应。

$0^\circ$ 是波形的起始点。对于正弦波、方波或三角波、斜波， $0^\circ$ 对应 0V 电压(假设没有 DC 偏置)。

脉冲串相位用于 N 次循环和门控脉冲串模式。在门控脉冲串模式下，当 Trigger INPUT 信号下降到低电平时，信号发生器完成当前波形后停止输出。电压输出电平仍与起始脉冲串相位对应的电压值相同。

## 脉冲串触发源

触发脉冲串(N-Cycle)模式下，信号发生器每接收一个触发就输出一个波形脉冲串。脉冲串循环(脉冲串计数)指定每个脉冲串的波形数。一个脉冲串输出完成后，信号发生器停止并等待下一次触发。默认内部源触发的脉冲串(N-cycle)模式。

### 面板操作

1. 按 Burst 键



2. 按 F1 (N Cycle)



3. 按 F5 (TRIG set)



4. 按 F1 (INT), F2 (EXT)或 F3 (Manual)选择触发类型

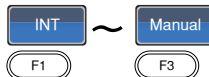

### 手动触发

如果选择手动触发，每按一次触发键(F1)输出一个脉冲串。



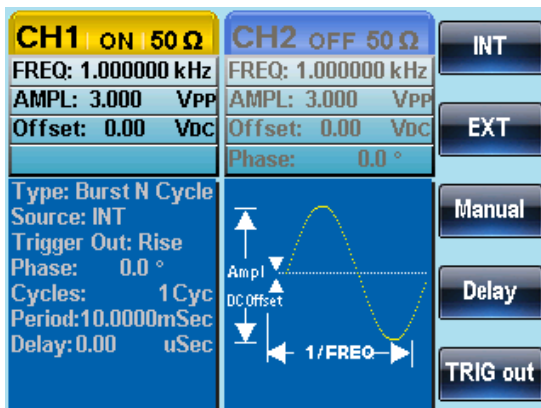

注意

选择内部触发源时，脉冲串通过脉冲串周期设置以指定频率持续输出。各脉冲串之间的时间间隔由脉冲串周期决定。

选择外部触发时，信号发生器接收后面板 Trigger INPUT 端的触发信号(TTL)。每收到一个触发信号，信号发生器就输出一个脉冲串(循环数已设)。输出脉冲串期间忽略接收到的触发信号。

若使用手动或外部触发，仅可使用脉冲串相位和脉冲串循环/计数，脉冲串周期不可用。





在接收触发后、脉冲串开始前可以插入一个时间延迟。

## 脉冲串延迟

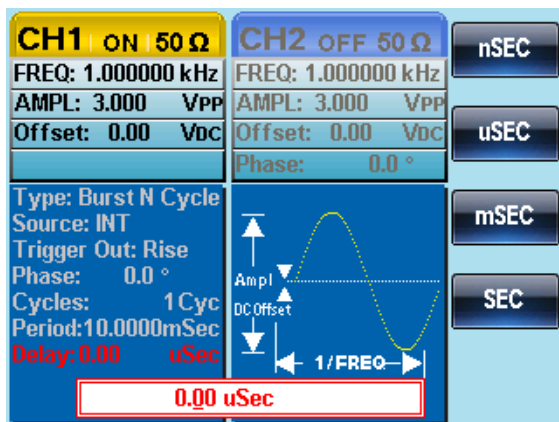
面板操作

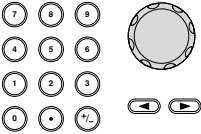
1. 按 Burst 键 
2. 按 F1 (N Cycle)  
3. 按 F5 (TRIG set)  
4. 按 F4 (Delay)  
5. 在波形显示区域内的 Delay 参数变亮



6. 使用方向键和可调旋钮或数字键盘输入延迟时间 
7. 按 F1~F4 选择延迟时间单位    

范围	延迟时间	0s~655350nS
	默认	0s

## 脉冲串触发输出

在脉冲串和扫描模式下，使用后面板的 Trig Out 端子输出一个上升沿 TTL 兼容触发信号。默认触发信号为上升沿，在每个脉冲串开始时输出。

### 面板操作

1. 按 Burst 键



2. 按 F1 (N Cycle)



3. 按 F5 (TRIG set)



4. 按 F5 (TRIG out)



5. 按 F3 (ON/OFF)开启/关闭触发输出



6. 选择 F1 (Rise)或 F2 (Fall)边沿触发

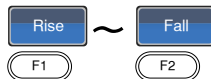

### 注意

当选择内部或外部触发源时，在一次触发脉冲完成的同时，在触发输出端口由一个高或低的同步信号输出。

选择手动触发时，每按一次手动按钮，就会有一次触发输出。

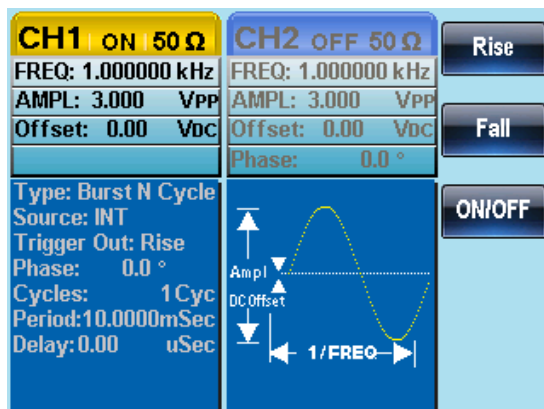

# 辅助系统功能设置

辅助系统功能设置包括存储和调取设置、查阅帮助文件、查阅软件版本、更新固件、设置蜂鸣器。

---

存储和调取.....	128
系统和设置.....	131
查阅和更新固件版本.....	131
设置蜂鸣器声音.....	131

## 存储和调取

AFG-2225 的非易失性存储器有 10 个内存文件 0~9，可以保存仪器状态、波形数据(ARB)和设置。若内存文件中存有数据(ARB 或设置数据)，则数据以红色字体显示；若没有数据则呈现蓝色。

### 存储/调取内容

#### ARB

- 速率
- 频率
- 长度
- 显示水平位置
- 显示垂直位置
- 输出开始
- 输出长度

#### 设置

- 功能
  - 波形
  - 频率
  - 脉冲宽度
  - 方波占空比
  - 斜波对称性
  - 幅值
  - 幅值单位
  - 偏移
  - 调制类型
  - 蜂鸣器设置
  - 阻抗
  - 主输出
- Sweep
  - 源
  - 类型
  - 标记
  - 时间
- AM
  - 调制源
  - 波形
  - 深度
  - AM 频率
- FM
  - 调制源
  - 波形
  - 偏移
  - FM 频率
- FSK
  - 调制源
  - 波形
  - 速率
  - 跳跃频率
- PM
  - 调制源
  - 波形



- 起始频率
- 停止频率
- 中心频率
- 跨距频率
- 标记频率
- 相位偏移
- 频率
- 脉冲串类型
  - 源
  - 触发
  - 类型
  - 循环数
  - 相位
  - 周期
  - 延迟

面板操作

1. 按 UTIL 键



2. 按 F1 (Memory)



3. 使用可调旋钮选择一个内存文件

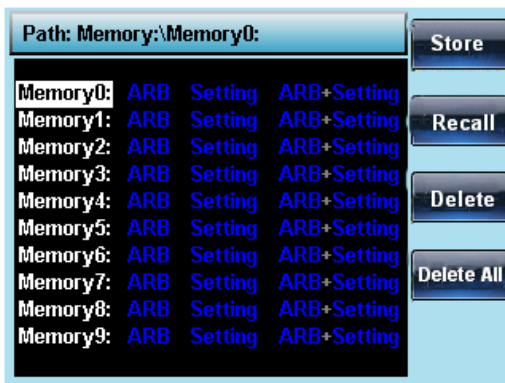
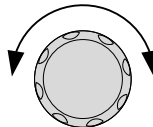

4. 选择文件操作:

按 F1 存储文件, F2 调取文件,  
F3 删除文件

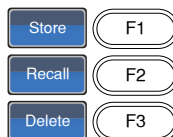

5. 使用可调旋钮选择一个数据类型

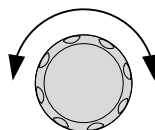

ARB, 设置 或 ARB+设置

6. 按 F5 (Done)确认



范围

内存文件

Memory0 ~ Memory9

数据类型

ARB, Setting, ARB+Setting

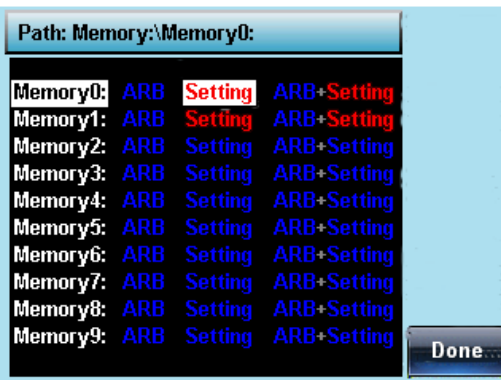

7. 按 F5 (Done)确认



全部删除

8. 按 F4 删除 Memory 0 ~  
Memory 9 所有文件



9. 按 F1 (Done)确认删除



## 系统和设置

用户也可以进行固件版本和其它设置。



### 查阅和更新固件版本

---

- |      |                         |   |
|------|-------------------------|---|
| 查阅版本 | 1. 按 UTIL 键             |    |
|      | 2. 按 F2 (Cal.)          |   |
|      | 3. 按 F2 (Software)      |   |
|      | 4. 按 F1 (Version)查阅固件版本 |   |

屏幕显示版本信息：  
仪器, 版本, FPGA 版次

---

- |      |  |   |
|------|--|---|
| 更新固件 | 5. 将存有固件文件的 U 盘插入 USB host, 按 F2 (Upgrade)更新固件 |   |
|------|--|---|
- 





文件必须是 (\*.bin) 格式文件, 位于 USB 根目录下







---

### 设置蜂鸣器声音

---



背景 开启或关闭蜂鸣器。

- |      |                  |   |
|------|------------------|---|
| 面板操作 | 1. 按 UTIL 键      |    |
|      | 2. 按 F3 (System) |   |

3. 按 F3 (Beep)开启或关闭蜂鸣器  
4. 按 F1(ON)或 F2(OFF)    



## 频率计

例如: 开启频率计。门限时间: 1 s

输出: N/A      1. 按 UTIL, F5 (Counter)  

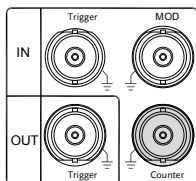
输入:



2. 按 F1 (Gate Time), 按 F3 (1 Sec)选择 1s 门限时间  
3. 将感兴趣的信号与后面板的频率计输入端相连

4. 输入 1kHz 方波到后面板 Counter 输入端。设置门限时间 1s

<b>CH1 OFF 50 Ω</b>	<b>CH2 OFF 50 Ω</b>	<b>0.01 Sec</b>
FREQ: 1.000000 kHz	FREQ: 1.000000 kHz	<b>0.1 Sec</b>
AMPL: 3.000 V <sub>PP</sub>	AMPL: 3.000 V <sub>PP</sub>	
Offset: 0.00 V <sub>DC</sub>	Offset: 0.00 V <sub>DC</sub>	<b>1 Sec</b>
Phase: 0.0 °	Phase: 0.0 °	
Gate Time: 1 Second		<b>10 Sec</b>
Frequency Counter Value: 1.000000 kHz		

## 频率耦合





例如: 频率耦合

1. 按 UTIL, F4 (Dual Chan)进入耦合功能  
2. 按 F1 (Freq Cpl)选择频率耦合功能 
3. 按 F2 (Offset)。偏移值是 CH1 和 CH2 的频率差。使用数字键或可调旋钮输入偏移值 

两种不同的耦合模式。计算公式如下:

$$\text{Offset}=\text{CH2}-\text{CH1}$$

$$\text{Ratio}=\text{CH2}/\text{CH1}$$

4. 输入 1kHz 偏移值。按 F1~ F5 选择单位    

Ch2 的频率变为 2kHz (CH2=CH1 + Offset)。

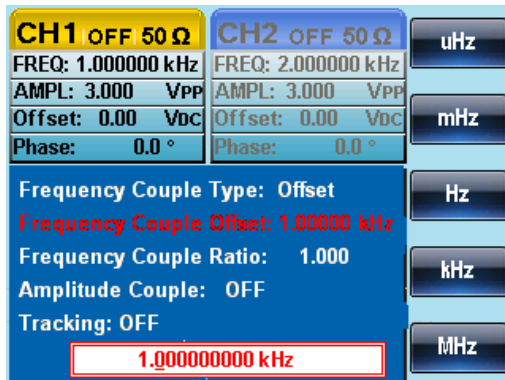

- 将频率耦合模式改成 Ratio。设置 Ratio 等于 2  
CH2 的频率自动根据匹配比率改变 (CH2=CH1\*Ratio)

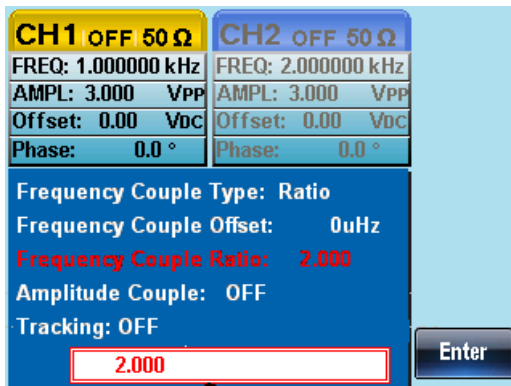

## 幅值耦合

例如: 幅值耦合

- 假设幅值已设为 4Vpp, 且具有 1Vdc 的 DC 偏置

2. 按 UTIL, F4 (Dual Chan)进入耦合功能  
3. 按 F2 (Ampl Cpl), F1 (ON)选择幅值耦合功能  
4. 两通道的幅值和偏移已耦合。在当前通道的任何幅值变化都将影响到另一通道

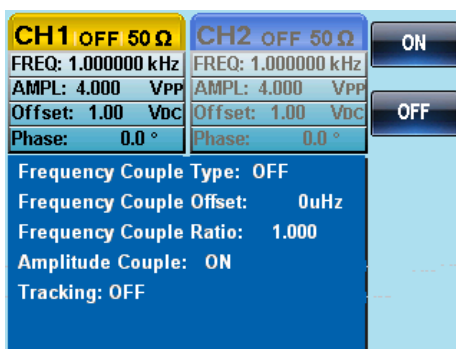

## 追踪

例如: 追踪

5. 通道一设为一个方波，频率为 2kHz,幅度为 5Vpp ,DC Offset 为 1Vdc
6. 按 UTIL, F4 (Dual Chan)进入耦合功能  
7. 按 F3 (Tracking), F2 (On)开启追踪功能  
8. 开启追踪功能时，当前通道的参数(如幅值和频率)将反射到另一通道

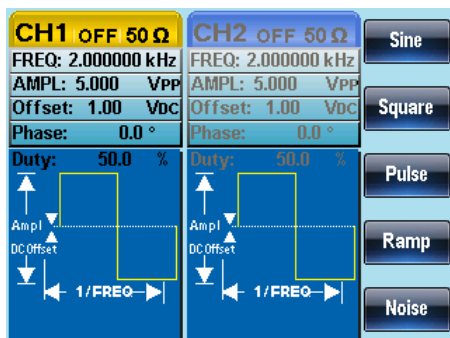
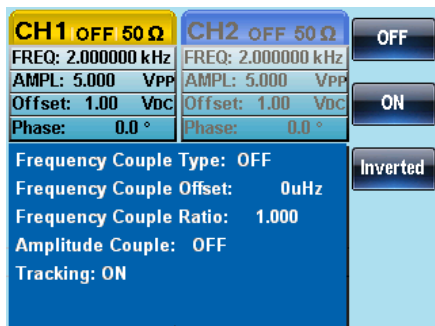

## 同步

例子：同步

1. 按 UTIL, Dual Chan (F4) 打开耦合功能



2. 按 S\_Phase (F4), 打开同步功能



3. S\_Phase 功能是使当前通道的相位与另一个通道的相位同步，且同步后的相位为  $0^\circ$ 。这里的 S\_Phase 功能与 CH1/CH2 菜单下的 S\_Phase 功能相同。



# 通道设置

通道设置章节介绍如何设置输出阻抗、输出相位和 DSO 连接设置。

输出阻抗 .....	137
选择输出相位 .....	138
同步双通道相位 .....	139
DSO 连接 .....	140

## 输出阻抗

**背景** AFG-2225 提供可选输出阻抗: 50Ω(默认)或高阻。输出阻抗仅供参考, 如果与实际负载阻抗不同, 那么实际幅值和偏移也将相应改变。

### 面板操作

1. 按 CH1/CH2 键

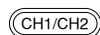

### 注意

如果 ARB, MOD, SWEEP 或 BURST 功能关闭, 才可以使用负载功能。

2. 按 F1 (Load)



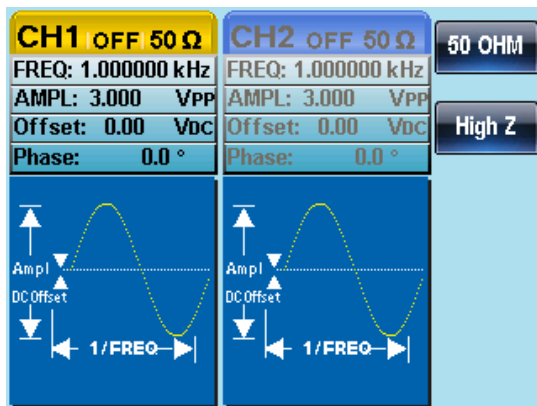

3. 按 F1 (50 OHM)或 F2 (High Z)选择输出阻抗

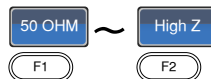

## 选择输出相位

面板操作

1. 按 CH1/CH2 键



注意

如果 ARB, MOD, SWEEP 或 BURST 功能关闭, 才可以使用相位功能。方波和脉冲波的相位不可调, 且为 0 度

2. 按 F4 (Phase)和 F1 (Phase)



3. 在参数窗口内的 Phase 参数变亮



4. 使用方向键和可调旋钮或数字键盘输入输出相位

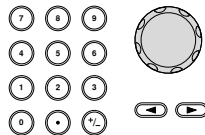

5. 按 F5 (Degree)

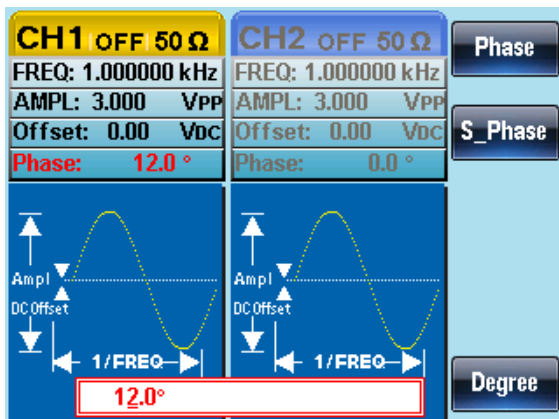

## 同步双通道相位

背景 使 AFG-2225 同步输出。

面板操作

1. 按 CH1/CH2 键

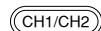

2. 按 F4 (Phase)



3. 按 F2 (S\_Phase)同步两通道的相位



## DSO 连接

### 背景

DSO 连接使 AFG-2225 无损接收从 GDS-2000 系列数字存储示波器传来的数据。

1. 将 AFG-2225 USB host 接口与 GDS-2000 的 USB B device 接口相连

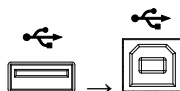

### 面板操作

2. 按 CH1/CH2 键



3. 按 F5 (DSO Link)



4. 按 F1 (Search)



5. 按 F2 (CH1), F3 (CH2), F4 (CH3)或 F5 (CH4)选择一个 DSO 通道。屏幕显示捕获的数据

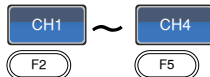

# 任意波形

AFG-2225 能够创建自定义的任意波形，采样率 120MHz。每个波形 4k 数据点，垂直范围在 $\pm 511$  以内。

---

插入内置波形 .....	142
创建 AbsAtan 波形.....	142
显示任意波形 .....	144
设置水平显示范围 .....	144
设置垂直显示范围 .....	146
页面浏览(前移).....	148
页面浏览(后移).....	150
显示 .....	152
编辑任意波形 .....	153
增加一个点 .....	153
增加一条线 .....	154
复制波形 .....	156
清除波形 .....	158
ARB 保护 .....	160
输出任意波形 .....	163
输出任意波形 .....	163
存储/调取任意波形.....	165
将波形保存至内部存储器.....	165
将文件保存至 U 盘.....	166
从内部存储器调取波形.....	169
从 U 盘调取波形.....	172

## 插入内置波形

AFG-2225 可以创建 66 种常见波形，如 Math 波形、窗函数和工程函数。

### 创建 AbsAtan 波形

---

面板操作

1. 按 ARB 键 
2. 按 F3(Built in)  
3. 按 F4(Wave)  
4. 按 F1(Common)  
5. 使用可调旋钮从内置常见波形中选择“AbsAtan”
6. 按 F5(Select)选择 AbsAtan 波形  
7. 按 F1(Start)设置 AbsAtan 波形的起始位置  
8. 按 F2(Length)或 F3(Scale)可以改变波形的长度和刻度    
 
9. 按 F5 (Done)完成操作  
10. 按 Return 返回上层菜单 

---

如下 Absatan 波形，start:0, Length: 33, Scale: 511

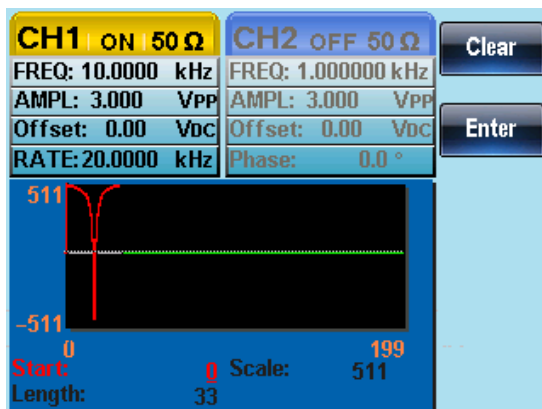

\*其它波形请参考附件内建波形表

## 显示任意波形

### 设置水平显示范围

两种方式设置水平视窗边界：使用起始点和长度；或使用中心点和长度。

#### 面板操作

1. 按 ARB 键



2. 按 F1 (Display) 进入显示菜单



3. 按 F1 (Horizon) 进入水平菜单



#### 使用起始点

4. 按 F1 (Start)



5. H\_From 参数变亮

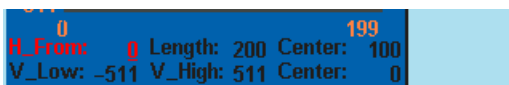

6. 使用方向键和可调旋钮或数字键盘输入 H\_From 值

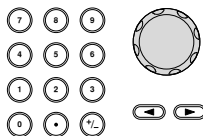

7. 按 Clear (F1) 取消



8. 按 F2 (Enter) 保存设置



9. 按 Return 返回上层菜单



#### 设置长度

10. 重复 4~9 步完成 Length (F2) 设置





- 使用中心点
11. 重复 4~9 步完成 Center (F3) 设置
- 
- Zoom in
12. 按 F4 (Zoom In) 放大任意波形，每次缩短一半长度。允许的最小长度为 3
- 
- Zoom out
13. 按 F5 (Zoom out) 沿波形中点缩小波形，每次增加一倍长度。允许的最大长度为 4096

如下任意波形，start: 0, length: 200, center: 100



## 设置垂直显示范围

与水平窗口类似，两种方式设置垂直显示范围：设置高和低值，或设置中心点。

面板操作

1. 按 ARB 键



2. 按 F1 (Display)



3. 按 F2 (Vertical)



设置最低点

4. 按 F1 (Low)



5. V\_Low 参数变亮

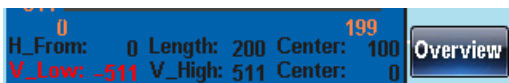

6. 使用方向键和可调旋钮或数字键盘输入 V\_Low 值

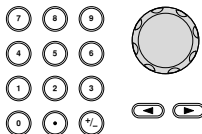

7. 按 Clear (F1)取消



8. 按 F2 (Enter)保存设置



9. 按 Return 返回上层菜单



设置最高点

10. 重复 4~9 步完成 V\_High (F2) 设置



设置中心点

11. 重复 4~9 步完成 Center (F3) 设置

Center

F3

Zoom

12. 按 F4 (Zoom in) 沿任意波形中心放大，每次缩短一半长度。允许最小垂直低点为-2，最小垂直高点为 2

Zoom in

F4

13. 按 F5 (Zoom out) 缩小波形，每次增加一倍长度。允许最大垂直低点为-511，最大垂直高点为+511

Zoom out

F5

如下 AbsAtan 波形，vertical low: -511, vertical high: 511, center: 0



## 页面浏览(前移)

---

背景                      观察波形时，使用 Next/Back Page 功能可以向前/后移动显示窗口。

面板操作

1. 按 ARB 键



2. 按 F1 (Display)



3. 按 F4 (Back Page)将显示窗口  
向前移动一个观察长度



$H\_From^* = H\_From - Length$

$Center^* = Center - Length$

\*Length until 0

如下，按 Back Page 之后的显示窗口。

H\_From: 200 → 0

Length: 200

Center:300→ 100

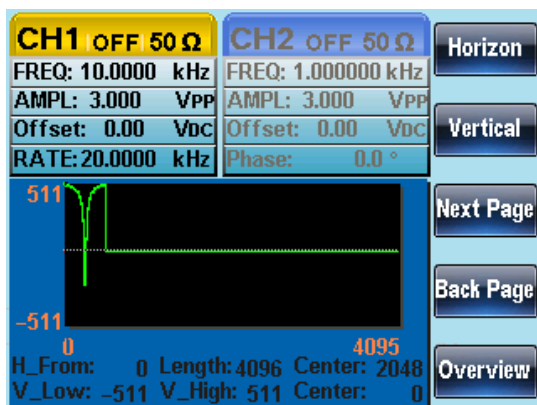
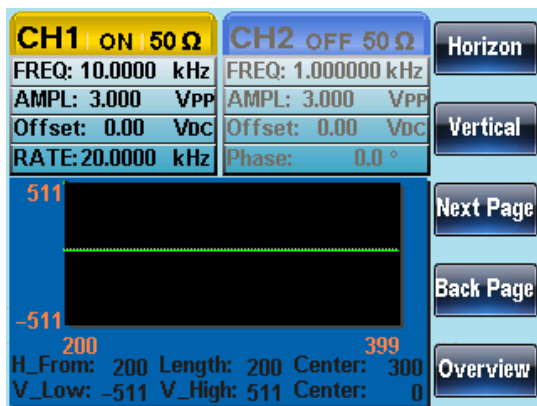

## 页面浏览(后移)

---

背景                      观察波形时，使用 Next/Back Page 功能可以向前/后移动显示窗口。

面板操作

1. 按 ARB 键



2. 按 F1 (Display)



3. 按 F3 (Next Page)将显示窗口  
向后移动一个观察长度



$H\_From^* = H\_From + Length$

$Center = Center + Length$

$*H\_From + Length \leq 4096$

如下，按 Next Page 之后的显示窗口。

H\_From: 0 → 200

Length: 200

Center: 100 → 300



## 显示

面板操作

1. 按 ARB 键



2. 按 F1 (Display)



3. 按 F5 (Overview)显示整个波形



水平: 0~4095

垂直: 511~ -511

如下，按 Overview 之后的显示窗口。

H\_From: 0 → 0

Length: 400→4096

Center:200→ 2048

Vertical low/high: ±511

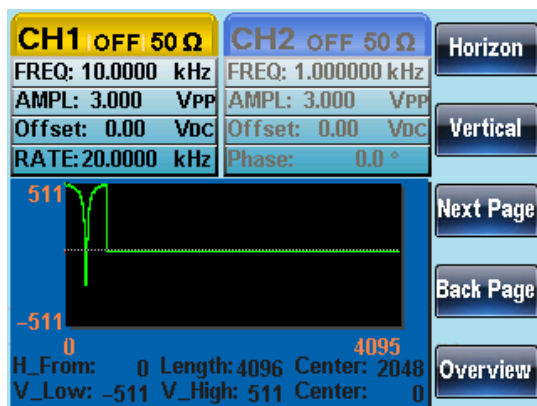



## 编辑任意波形

### 增加一个点

**背景** AFG-2225 提供强大的编辑功能，用户可以在波形的任何位置创建点或线。

#### 面板操作

1. 按 ARB 键



2. 按 F2 (Edit)



3. 按 F1 (Point)



4. 按 F1 (Address)



5. Address 参数变亮



6. 使用方向键和可调旋钮或数字键盘输入 Address 值

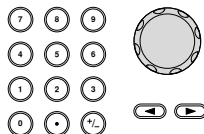

7. 按 F2 (Enter)保存设置



8. 按 Return 返回上层菜单



9. 按 F2 (Data)



10. Data 参数变亮

11. 使用方向键和可调旋钮或数字键盘输入 Data 值

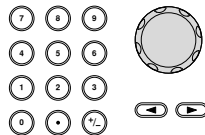

12. 按 F2 (Enter)保存设置



13. 按 Return 返回上层菜单



14. 再按 Return 返回 ARB 菜单



如下图，编辑区域(address)显示红色。

Address 100, Data 200

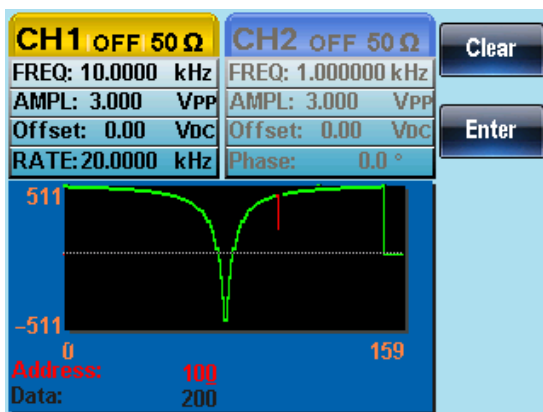

## 增加一条线

背景

AFG-2225 提供强大的编辑功能，用户可以在波形的任何位置创建点或线。

面板操作

1. 按 ARB 键



2. 按 F2 (Edit)



3. 按 F2 (Line)



4. 按 F1 (Start ADD)



5. Start Address 参数变亮



6. 使用方向键和可调旋钮或数字键盘输入起始地址(Start address)

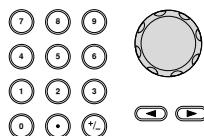

7. 按 F2 (Enter)保存设置



8. 按 Return 返回上层菜单



9. 重复 4~8 步完成 Start Data (F2)设置、Stop Address (F3)设置和 Stop Data (F4)设置

10. 按 F5 (Done)确认操作



11. 按 Return 返回上层菜单



如下图，编辑线显示红色。

Start Address: 0, Start Data: 0

Stop Address: 32, Stop Data: 0

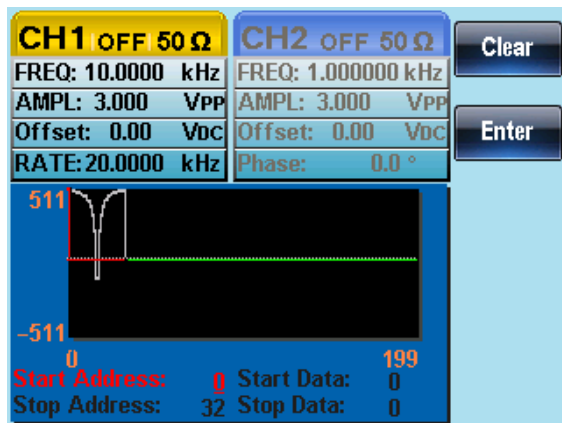

## 复制波形

面板操作

1. 按 ARB 键



2. 按 F2 (Edit)



3. 按 F3 (Copy)



4. 按 F1 (Start)



5. Copy From 参数变亮



6. 使用方向键和可调旋钮或数字键盘输入复制波形(Copy From)的地址

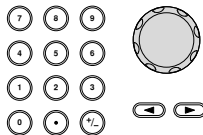

7. 按 F2 (Enter)保存设置



8. 按 Return 返回上层菜单

Return

9. 重复 4~8 步完成 Length (F2)和 Paste To (F3)设置

10. 按 F5 (Done)确认操作

Done

F5

11. 按 Return 返回上层菜单

Return

将波形中的点 0~33 复制到点 50~83:

Copy From: 0

Length: 33

To: 50

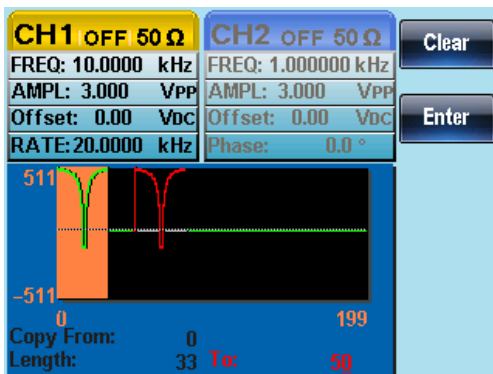

## 清除波形

面板操作

1. 按 ARB 键



2. 按 F2 (Edit)



3. 按 F4 (Clear)



4. 按 F1 (Start)



5. Clear From 参数变亮



6. 使用方向键和可调旋钮或数字键盘输入清除波形(Clear From)的地址

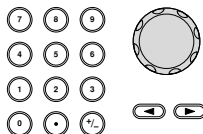

7. 按 F2 (Enter)保存设置



8. 按 Return 返回上层菜单



9. 重复 4~8 步完成 Length (F2) 设置



10. 按 F3 (Done)清除所选部分



全部删除

11. 按 F4 (ALL)删除整个波形



12. 按 F1 (Done)再次确认删除



13. 按 Return 返回上层菜单



Clear From: 20, Length: 33.



清除部分波形后:

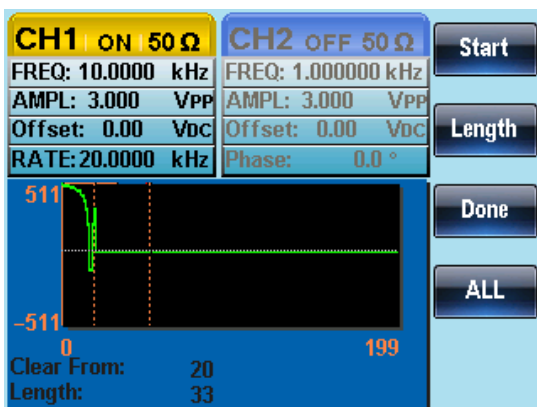

删除整个波形后:



## ARB 保护

保护任意波形的某个区域不被改变。

面板操作

1. 按 ARB 键



2. 按 F2 (Edit)



3. 按 F5 (Protect)



4. 按 F2 (Start)



5. Protect Start 参数变亮



6. 使用方向键和可调旋钮或数字键盘输入 Protect Start 地址

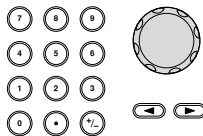



---

	7. 按 F2 (Enter)保存设置		
	8. 按 Return 返回上层菜单		
	9. 重复 4~8 步完成 Length (F3) 设置		
	10. 按 F4 (Done)确认保护区域		
保护整个波形	11. 按 F1 (ALL)保护整个波形		
	12. 按 F1 (Done)确认		
解除保护	13. 按 F5 (Unprotect)解除保护波形		
	14. 按 F1 (Done)确认		
	15. 波形背景变回黑色。“Protect Off”呈灰色		

---

如下，波形保护区域以橘色背景显示：

Start:0, Length: 100



## 输出任意波形

信号发生器能够输出高达 4k(2~4096)点的任意波形。

### 输出任意波形

面板操作

1. 按 ARB 键



2. 按 F4 (Output)



3. 按 F1 (Start)



4. Start 参数变亮



5. 使用方向键和可调旋钮或数字键盘输入起始(Start)点地址

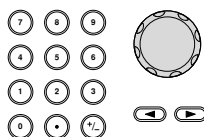

6. 按 F2 (Enter)确认



7. 按 Return 返回上层菜单



8. 重复 4~7 步完成 Length (F2) 设置



9. 按 Return 返回上层菜单



前面板端子输出如下波形：

Start 0, Length 500

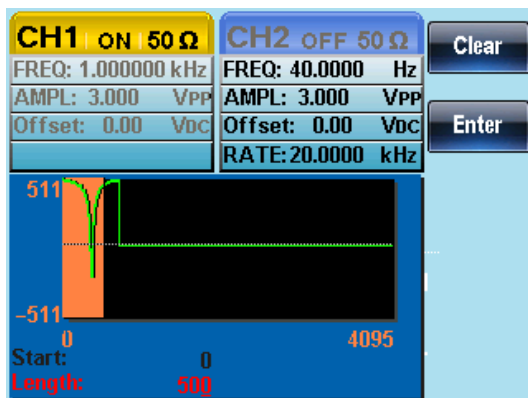

### \*任意波形标记输出

当任意波形被开启时，无论任意波有无输出，都会从触发输出口输出一个脉冲波，脉冲波的频率是  $1/\text{Rate}$

## 存储/调取任意波形

AFG-2225 可以在 10 组内存中存储和调取任意波形。任意波形也能在 U 盘里保存和调取。

### 将波形保存至内部存储器

面板操作

1. 按 ARB 键



2. 按 F5 (More)



3. 按 F1 (Save)



4. 按 F1 (Start)



5. Start 参数变亮

6. 使用方向键和可调旋钮或数字键盘输入 Start 地址

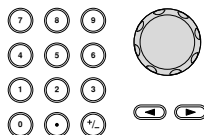

7. 按 F2 (Enter) 确认



8. 按 Return 返回上层菜单



9. 重复 4~8 步完成 Length (F2) 设置



10. 按 F3 (Memory)



11. 使用可调旋钮选择内存文件

Memory0~Memory9

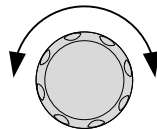

12. 按 F1 (Select)将波形保存至所选内存文件



13. 按 Return 返回上层菜单



如下，使用可调旋钮选择 Memory0 文件。

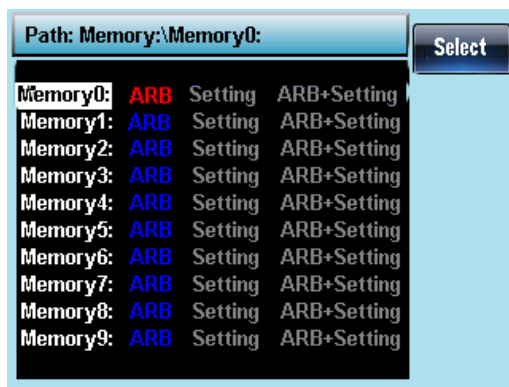

## 将文件保存至 U 盘

面板操作

1. 按 ARB 键



2. 按 F5 (More)



3. 按 F1 (Save)



4. 按 F1 (Start)



5. Start 参数变亮

6. 使用方向键和可调旋钮或数字键盘输入 Start 地址

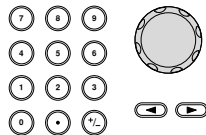

7. 按 F2 (Enter) 确认



8. 按 Return 返回上层菜单



9. 重复 4~8 步完成 Length (F2) 设置



10. 按 F4 (USB)



11. 使用可调旋钮浏览文件系统

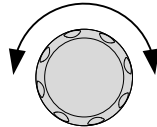

12. 按 Select 选择目录或文件



## 创建文件夹

1. 按 F2 (New Folder)



2. 显示默认文件夹名称“NEW\_FOL”

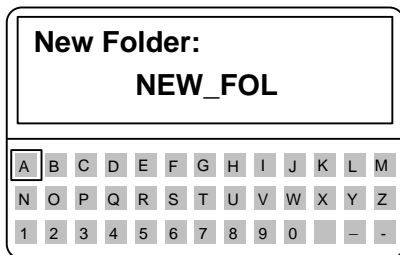

3. 使用可调旋钮移动光标

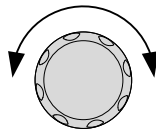

4. 按 F1 (Enter Char)或 F2 (Backspace)创建文件夹名称



5. 按 F5 (Save)保存文件夹名称



### 创建新文件

1. 按 F3 (New File)



2. 显示默认文件名“NEW\_FIL”

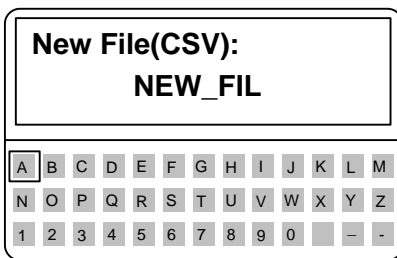

3. 使用可调旋钮移动光标

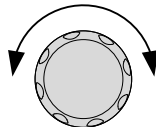

4. 按 F1 (Enter Char)或 F2 (Backspace)创建文件名



5. 按 F5 (Save)保存



如图，在根目录下创建文件夹 BIN。





## 从内部存储器调取波形

面板操作

1. 按 ARB 键



2. 按 F5 (More)



3. 按 F2 (Load)



4. 按 F1 (Memory)



5. 使用可调旋钮选择内存文件

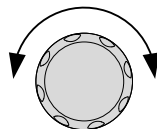

6. 按 Select 调取所选内存文件



7. 按 F3 (To)选择调取波形的起始点



8. Load To 参数变亮



9. 使用方向键和可调旋钮或数字键盘输入起始点

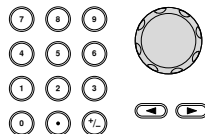

10. 按 F2(Enter)确认



11. 按 Return 返回上层菜单



12. 按 F4(Done)



如下，使用可调旋钮将 Memory0 文件调取到波形的 0 点(position 0)。

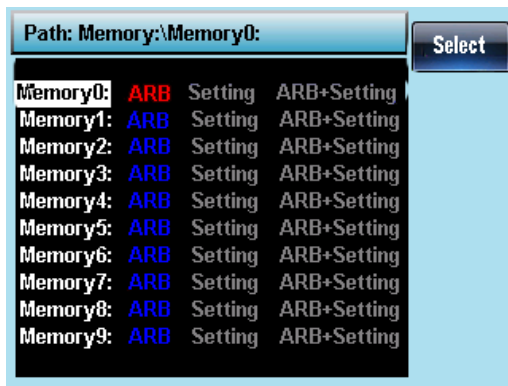

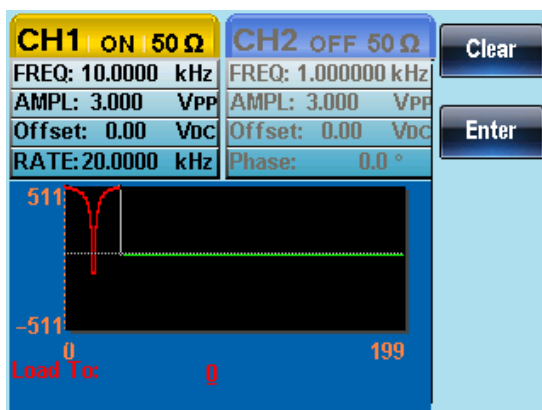

## 从 U 盘调取波形

面板操作

1. 按 ARB 键



2. 按 F5 (More)



3. 按 F2 (Load)



4. 按 F2 (USB)



5. 使用可调旋钮选择文件名

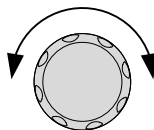

6. 按 F1 (Select)选择文件



7. 按 F3 (To)选择调取波形的起始点



8. Load To 参数变亮

9. 使用方向键和可调旋钮或数字键盘输入起始点

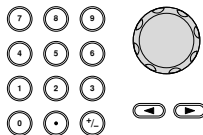

10. 按 F2(Enter)确认



11. 按 F4(Done)



如下，使用可调旋钮选择文件 AFG.CSV，调取至 position 0。

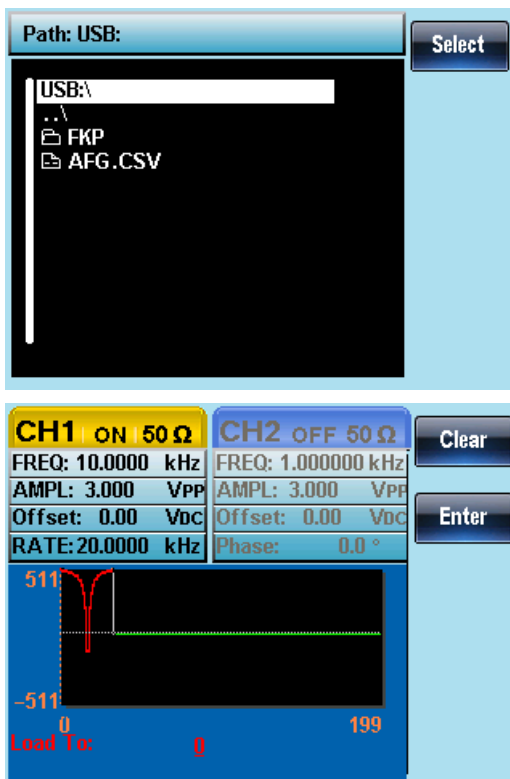

# 远 程 接 口

---

Establishing a Remote Connection .....	175
Configure USB interface .....	175
Remote control terminal connection.....	176
Command Syntax.....	178
Error Messages .....	266
Command Error Codes .....	266
Execution Errors .....	268
Query Errors .....	272
Arbitrary Waveform Errors .....	272
SCPI Status Register .....	274
Register types .....	274
AFG-2225 Status System .....	275
Questionable Status Register .....	276
Standard Event Status Registers .....	276
The Status Byte Register .....	277
Output Queue.....	278
Error Queue.....	279

## Establishing a Remote Connection

The AFG-2225 supports USB remote connections.

### Configure USB interface

USB configuration	PC side connector	Type A, host
	AFG-2225 side connector	Type B, slave
	Speed	1.1/2.0 (full speed)



Panel Operation 1. Connect the USB cable to the rear panel USB B (slave) port.



- When the PC asks for the USB driver, select XXXXXXXX.inf included in the software package or download the driver from the GW website, [www.gwinstek.com](http://www.gwinstek.com).

## Remote control terminal connection

---

Terminal application	<p>Invoke the terminal application such as MTTY (Multi-Threaded TTY). For USB, set the COM port, baud rate, stop bit, data bit, and parity accordingly.</p> <p>To check the COM port No, see the Device Manager in the PC. For WinXP, Control panel → System → Hardware tab.</p>
Functionality check	<p>Run this query command via the terminal.</p> <pre>*!dn?</pre> <p>This should return the Manufacturer, Model number, Serial number, and Firmware version in the following format.</p> <pre>GW INSTEK, AFG-2225, SN:XXXXXXXX, Vm.mm</pre> <p>Note: ^j or ^m can be used as the terminal character when using a terminal program.</p>
PC Software	<p>The proprietary PC software, downloadable from GWInstek website, can be used for remote control.</p>
Display	<p>When a remote connection is established all panel keys are locked bar F5.</p> <ol style="list-style-type: none"><li>1. Press REM/LOCK (F5) to return the function generator to local mode.</li></ol> <div style="display: flex; align-items: center; gap: 10px;"></div>





## Command Syntax

Compatible standard	<ul style="list-style-type: none"> <li>• IEEE488.2, 1992 (fully compatible)</li> <li>• SCPI, 1994 (partially compatible)</li> </ul>
---------------------	---

**Command Tree** The SCPI standard is an ASCII based standard that defines the command syntax and structure for programmable instruments.

Commands are based on a hierarchical tree structure. Each command keyword is a node on the command tree with the first keyword as the root node. Each sub node is separated with a colon.

Shown below is a section of the `SOURce[1|2]` root node and the `:PM` and `:PULSe` sub nodes.

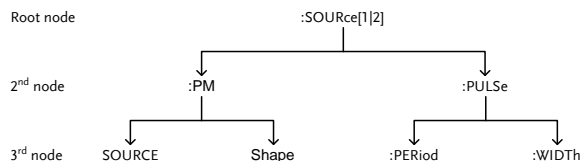

**Command types** Commands can be separated in to three distinct types, simple commands, compound commands and queries.

Simple	A single command with/without a parameter
Example	*OPC
Compound	Two or more commands separated by a colon (:) with/without a parameter
Example	SOURce1:PULSe:WIDTh

Query	A query is a simple or compound command followed by a question mark (?). A parameter (data) is returned. The maximum or minimum value for a parameter can also be queried where applicable.
Example	SOURce1:FREQuency? SOURce1:FREQuency? MIN

Command forms    Commands and queries have two different forms, long and short. The command syntax is written with the short form of the command in capitals and the remainder (long form) in lower case.

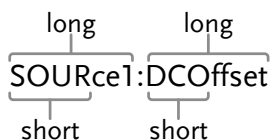

The commands can be written in capitals or lower-case, just so long as the short or long forms are complete. An incomplete command will not be recognized.

Below are examples of correctly written commands:

---

LONG    SOURce1:DCOffset  
          SOURCE1:DCOFFSET  
          source1:dcoffset

---

SHORT SOUR1:DCO  
          sour1:dco

---

Command Format	$\text{SOURCE1:DCOffset} \underbrace{\quad}_{1} \underbrace{\quad}_{2} \underbrace{\langle \text{offset} \rangle}_{3} \underbrace{\text{LF}}_{4}$	1: command header 2: single space 3: parameter 4: message terminator
-------------------	---	---

**Square Brackets []** Commands that contain squares brackets indicate that the contents are optional. The function of the command is the same with or without the square bracketed items. Brackets are not sent with the command.

For example, the frequency query below can use any of the following 3 forms:

SOURCE1:FREQUENCY? [MINimum|MAXimum]

SOURCE1:FREQUENCY? MAXimum

SOURCE1:FREQUENCY? MINimum

SOURCE1:FREQUENCY?

**Braces {}** Commands that contain braces indicate one item within the braces must be chosen. Braces are not sent with the command.

**Angled Brackets <>** Angle brackets are used to indicate that a value must be specified for the parameter. See the parameter description below for details. Angled brackets are not sent with the command.

**Bars |** Bars are used to separate multiple parameter choices in the command format.

Parameters	Type	Description	Example
	<Boolean>	Boolean logic	0, 1/ON,OFF
	<NR1>	integers	0, 1, 2, 3
	<NR2>	decimal numbers	0.1, 3.14, 8.5
	<NR3>	floating point	4.5e-1, 8.25e+1
	<NRf>	any of NR1, 2, 3	1, 1.5, 4.5e-1

	<NRf+> <Numeric>	NRf type with a suffix including MINimum, MAXimum or DEFault parameters.	1, 1.5, 4.5e-1 MAX, MIN,
	<aard>	Arbitrary ASCII characters.	
	<discrete>	Discrete ASCII character parameters	IMM, EXT, MAN
	<frequency> <peak deviation in Hz> <rate in Hz>	NRf+ type including frequency unit suffixes.	1 KHZ, 1.0 HZ, MHZ
	<amplitude>	NRf+ type including voltage peak to peak.	VPP
	<offset>	NRf+ type including volt unit suffixes.	V
	<seconds>	NRf+ type including time unit suffixes.	NS, S MS US
	<percent> <depth in percent>	NRf type	N/A
Message terminators	LF CR	line feed code (new line) and carriage return.	
	LF	line feed code (new line)	
	EOI	IEEE-488 EOI (End-Or-Identify)	
 Note	λj or λm should be used when using a terminal program.		

Command Separators	Space	A space is used to separate a parameter from a keyword/command header.
	Colon (:)	A colon is used to separate keywords on each node.
	Semicolon (;)	A semi colon is used to separate subcommands that have the same node level.  For example: SOURce[1 2]:DCOffset? SOURce[1 2]:OUTPut? →SOURce1:DCOffset?;OUTPut?
	Colon + Semicolon (;:)	A colon and semicolon can be used to combine commands from different node levels.  For example: SOURce1:PM:SOURce? SOURce:PULSe:WIDTh? →SOURce1:PM:SOURce?::SOURce:PULSe:WIDTh?
Comma (,)	When a command uses multiple parameters, a comma is used to separate the parameters.  For example: SOURce:APPLy:SQUare 10KHZ, 2.0 VPP, -1V	

## Command List

System Commands .....	187
SYSTem:ERRor? .....	187
*IDN? .....	187
*RST .....	188
SYSTem:VERSion? .....	188
*OPC .....	188
*OPC? .....	189
*WAI .....	189
Status Register Commands .....	190
*CLS .....	190
*ESE .....	190
*ESR? .....	191
*STB? .....	191
*SRE .....	192
System Remote Commands .....	193
SYSTem:LOCal .....	193
SYSTem:REMote .....	193
Apply Commands .....	194
SOURce[1 2]:APPLY:SINusoid .....	196
SOURce[1 2]:APPLY:SQUare .....	196
SOURce[1 2]:APPLY:RAMP .....	197
SOURce[1 2]:APPLY:PULSe .....	197
SOURce[1 2]:APPLY:NOISe .....	198
SOURce[1 2]:APPLY:USER .....	198
SOURce[1 2]:APPLY? .....	199
Output Commands .....	200
SOURce[1 2]:FUNction .....	200
SOURce[1 2]:FREQuency .....	201
SOURce[1 2]:AMPlitude .....	203
SOURce[1 2]:DCOffset .....	204
SOURce[1 2]:SQUare:DCYCLE .....	205
SOURce[1 2]:RAMP:SYMMetry .....	206
OUTPut[1 2] .....	206
OUTPut[1 2]:LOAD .....	207
SOURce[1 2]:VOLTage:UNIT .....	208
Pulse Configuration Commands .....	209
SOURce[1 2]:PULSe:PERiod .....	209
SOURce[1 2]:PULSe:WIDTh .....	210
Amplitude Modulation (AM) Commands .....	211
AM Overview .....	211
SOURce[1 2]:AM:STATe .....	212

SOURce[1 2]:AM:SOURce .....	212
SOURce[1 2]:AM:INternal:FUNction .....	213
SOURce[1 2]:AM:INternal:FREQuency .....	214
SOURce[1 2]:AM:DEPth .....	214
Frequency Modulation (FM) Commands .....	216
FM Overview .....	216
SOURce[1 2]:FM:STATe .....	217
SOURce[1 2]:FM:SOURce .....	217
SOURce[1 2]:FM:INternal:FUNction .....	218
SOURce[1 2]:FM:INternal:FREQuency .....	219
SOURce[1 2]:FM:DEVIation .....	219
Frequency-Shift Keying (FSK) Commands .....	221
FSK Overview .....	221
SOURce[1 2]:FSKey:STATe .....	221
SOURce[1 2]:FSKey:SOURce .....	222
SOURce[1 2]:FSKey:FREQuency .....	222
SOURce[1 2]:FSKey:INternal:RATE .....	223
Phase Modulation (PM) Commands .....	225
PM Overview .....	225
SOURce[1 2]:PM:STATe .....	226
SOURce[1 2]:PM:SOURce .....	226
SOURce[1 2]:PM:INternal:FUNction .....	227
SOURce[1 2]:PM:INternal:FREQuency .....	227
SOURce[1 2]:PM:DEVIation .....	228
SUM Modulation (SUM) Commands .....	229
SUM Overview .....	229
SOURce[1 2]:SUM:STATe .....	230
SOURce[1 2]:SUM:SOURce .....	230
SOURce[1 2]:SUM:INternal:FUNction .....	231
SOURce[1 2]:SUM:INternal:FREQuency .....	231
SOURce[1 2]:SUM:AMPL .....	232
Frequency Sweep Commands .....	233
Sweep Overview .....	233
SOURce[1 2]:SWEep:STATe .....	234
SOURce[1 2]:FREQuency:STARt .....	235
SOURce[1 2]:FREQuency:STOP .....	235
SOURce[1 2]:FREQuency:CENTer .....	236
SOURce[1 2]:FREQuency:SPAN .....	237
SOURce[1 2]:SWEep:SPACing .....	238
SOURce[1 2]:SWEep:TIME .....	238
SOURce[1 2]:SWEep:SOURce .....	239
SOURce[1 2]:MARKer:FREQuency .....	240
SOURce[1 2]:MARKer .....	240
Burst Mode Commands .....	242



Burst Mode Overview.....	242
SOURce[1 2]:BURSt:STATe .....	244
SOURce[1 2]:BURSt:MODE .....	244
SOURce[1 2]:BURSt:NCYCles .....	245
SOURce[1 2]:BURSt:INTernal:PERiod .....	246
SOURce[1 2]:BURSt:PHASe .....	247
SOURce[1 2]:BURSt:TRIGger:SOURce .....	247
SOURce[1 2]:BURSt:TRIGger:DELay .....	248
SOURce[1 2]:BURSt:TRIGger:SLOPe .....	249
SOURce[1 2]:BURSt:GATE:POLarity .....	250
SOURce[1 2]:BURSt:OUTPut:TRIGger:SLOPe .....	250
OUTPut[1 2]:TRIGger .....	251
<b>Arbitrary Waveform Commands .....</b>	<b>252</b>
Arbitrary Waveform Overview .....	252
SOURce[1 2]:FUNCTion USER .....	253
DATA:DAC .....	253
SOURce[1 2]:ARB:EDIT:COPIY .....	254
SOURce[1 2]:ARB:EDIT:DELeTe .....	255
SOURce[1 2]:ARB:EDIT:DELeTe:ALL .....	255
SOURce[1 2]:ARB:EDIT:POINt.....	255
SOURce[1 2]:ARB:EDIT:LINE .....	256
SOURce[1 2]:ARB:EDIT:PROTeCt.....	256
SOURce[1 2]:ARB:EDIT:PROTeCt:ALL .....	257
SOURce[1 2]:ARB:EDIT:UNProTeCt.....	257
SOURce[1 2]:ARB:OUTPut .....	257
<b>COUNTER .....</b>	<b>258</b>
COUNTER:STATE.....	258
COUNTer:GATe .....	258
COUNTer:VALue? .....	259
<b>PHASE.....</b>	<b>260</b>
SOURce[1 2]:PHASe.....	260
SOURce[1 2]:PHASe:SYNChronize.....	260
SOURce[1 2]:PHASe:SYNChronize.....	260
SOURce1:PHASe:SYNChronize.....	260
<b>COUPLE .....</b>	<b>261</b>
SOURce[1 2]:FREQuency:COUPle:MODE.....	261
SOURce[1 2]:FREQuency:COUPle:OFFSet .....	261
SOURce[1 2]:FREQuency:COUPle:RATio .....	262
SOURce[1 2]:AMPlitude:COUPle:STATe .....	262
SOURce[1 2]:TRACk .....	263
<b>Save and Recall Commands .....</b>	<b>264</b>
*SAV .....	264
*RCL .....	264
MEMory:STATe:DELeTe.....	264

---

MEMory:STATe:DELeTe ALL ..... 265

## System Commands

### SYSTEM:ERRor? System Query

**Description** Reads an error from the error queue. See page 279 for details regarding the error queue.

**Query Syntax** **SYSTEM:ERRor?**

**Return parameter** <string> Returns an error string, <256 ASCII characters.

**Example** **SYSTEM:ERRor?**  
**-138 Suffix not allowed**  
 Returns an error string.

### \*IDN? System Query

**Description** Returns the function generator manufacturer, model number, serial number and firmware version number in the following format:  
 GW INSTEK,AFG-2225,SN:XXXXXXXX,Vm.mm

**Query Syntax** **\*IDN?**

**Return parameter** <string>

**Example** **\*IDN?**  
 GW INSTEK,AFG-2225,SN:XXXXXXXX,Vm.mm  
 Returns the identification of the function generator.

**\*RST** System Command

Description	Reset the function generator to its factory default state.
-------------	--

Note	Note the *RST command will not delete instrument save states in memory.
------	---

Syntax	<b>*RST</b>
--------	-------------

**SYSTEM:VERSion?** System Query

Description	Performs a system version query. Returns a string with the instrument, firmware version, FPGA revision
-------------	--

Query Syntax	<b>SYSTEM:VERSion?</b>
--------------	------------------------

Return parameter	<string>
------------------	----------

Example	<b>SYST:VERS?</b> AFG-2225 VX.XXX_XXXX Returns the year and version for that year (1).
---------	--

**\*OPC** System Command

Description	This command sets the Operation Complete Bit (bit 0) of the Standard Event Status Register after the function generator has completed all pending operations. For the AFG-2225, the *OPC command is used to indicate when a sweep or burst has completed.
-------------	---

Note	Before the OPC bit is set, other commands may be executed.
------	--

Syntax	<b>*OPC</b>
--------	-------------

<b>*OPC?</b>		System Query
Description	Returns the OPC bit to the output buffer when all pending operations have completed. I.e. when the OPC bit is set.	
Note	Commands cannot be executed until the *OPC? query has completed.	
Query Syntax	<b>*OPC?</b>	
Return parameter	1	
Example	<b>*OPC?</b> <b>1</b> Returns a "1" when all pending operations are complete.	
<b>*WAI</b>		System Command
Description	This command waits until all pending operations have completed before executing additional commands. I.e., when the OPC bit is set.	
Note	This command is only used for triggered sweep and burst modes.	
Syntax	<b>*WAI</b>	

## Status Register Commands

**\*CLS** System Command

**Description**      The \*CLS command clears all the event registers, the error queue and cancels an \*OPC command.

**Syntax**            **\*CLS**

**\*ESE** System Command

**Description**      The Standard Event Status Enable command determines which events in the Standard Event Status Event register can set the Event Summary Bit (ESB) of the Status Byte register. Any bit positions set to 1 enable the corresponding event. Any enabled events set bit 5 (ESB) of the Status Byte register.

**Note**              The \*CLS command clears the event register, but not the enable register.

**Syntax**            **\*ESE <enable value>**

**Parameter**        <enable value>      0~255

**Example**            **\*ESE 20**  
Sets a bit weight of 20 (bits 2 and 4).

**Query Syntax**     **\*ESE?**

Return Parameter	Bit	Register	Bit	Register
	0	Not used	4	Message Available
	1	Not used	5	Standard Event
	2	Error Queue	6	Master Summary
	3	Questionable Data	7	Not used

Example      **\*ESE?**  
                  **4**  
                  Bit 2 is set.

**\*ESR?** System Command

---

Description      Reads and clears the Standard Event Status Register. The bit weight of the standard event status register is returned.

---

Note                The \*CLS will also clear the standard event status register.

---

Query Syntax      **\*ESR?**

---

Return Parameter	Bit	Register	Bit	Register
	0	Operation Complete	4	Execution Error
	1	Not Used	5	Command Error
	2	Query Error	6	Not Used
	3	Device Error	7	Power On

---

Query Example    **\*ESR?**  
                  **5**  
                  Returns the bit weight of the standard event status register (bit 0 and 2).

**\*STB?** System Command

---

Description      Reads the Status byte condition register.

---

Note                Bit 6, the master summary bit, is not cleared.

---

Syntax             **\*STB?**

---

**\*SRE** System Command

**Description**      The Service Request Enable Command determines which events in the Status Byte Register are allowed to set the MSS (Master summary bit). Any bit that is set to "1" can cause the MSS bit to be set.

**Note**                The \*CLS command clears the status byte event register, but not the enable register.

**Syntax**             **\*SRE <enable value>**

**Parameter**        <enable value>      0~255

**Example**            **\*SRE 12**  
 Sets a bit weight of 12 (bits 2 and 3) for the service request enable register.

**Query Syntax**     **\*SRE?**

Return Parameter	Bit	Register	Bit	Register
	0	Not used	4	Message Available
	1	Not used	5	Standard Event
	2	Error Queue	6	Master Summary
	3	Questionable Data	7	Not used

**Query Example**    **\*SRE?**  
**12**  
 Returns the bit weight of the status byte enable register.



## System Remote Commands

### SYSTEM:LOCal System Command

---

Description      Sets the function generator to local mode. In local mode, all front panel keys are operational.

Syntax              **SYSTEM:LOCal**

Example             **SYST:LOC**

### SYSTEM:REMOte System Command

---

Description      Disables the front panel keys and puts the function generator into remote mode

Syntax              **SYSTEM:REMOte**

Example             **SYST:REM**

### DISPlay ON/OFF System Command

---

Description      Enable or disable the front panel display of function generator. When disabled, display does not display any content.

Due to disabling the front panel display, the speed of executing commands from the remote interface will be improved.

Syntax              **DISPlay ON/OFF**

Example             **DISPlay ON**

## Apply Commands

---

The APPLy command has 5 different types of outputs (Sine, Square, Ramp, Pulse, Noise, ). The command is the quickest, easiest way to output waveforms remotely. Frequency, amplitude and offset can be specified for each function.

As only basic parameters can be set with the Apply command, other parameters use the instrument default values.

The Apply command will set the trigger source to immediate and disable burst, modulation and sweep modes. Turns on the output commandOUTPut[1 | 2] ON. The termination setting will not be changed.

As the frequency, amplitude and offset parameters are in nested square brackets, amplitude can only be specified if the frequency has been specified and offset can only be specified if amplitude has been set. For the example:

```
SOURce[1 | 2]:APPLy:SINusoid [<frequency> [,<amplitude>
[,<offset>] ]]
```

**Output Frequency** For the output frequency, MINimum, MAXimum and DEFault can be used. The default frequency for all functions is set to 1 kHz. The maximum and minimum frequency depends on the function used. If a frequency output that is out of range is specified, the max/min frequency will be used instead. A "Data out range error will be generated" from the remote terminal.

---

---

**Output  
Amplitude**

When setting the amplitude, MINimum, MAXimum and DEFault can be used. The range depends on the function being used and the output termination (50Ω or high impedance). The default amplitude for all functions is 100 mVpp (50Ω).

If the amplitude has been set and the output termination is changed from 50Ω to high impedance, the amplitude will double. Changing the output termination from high impedance to 50Ω will half the amplitude.

Vrms, dBm or Vpp units can be used to specify the output unit to use with the current command. The VOLT:UNIT command can be used to set the units when no unit is specified with the Apply command. If the output termination is set to high impedance, dBm units cannot be used. The units will default to Vpp.

The output amplitude can be affected by the function and unit chosen. Vpp and Vrms or dBm values may have different maximum values due to differences such as crest factor. For example, a 5Vrms square wave must be adjusted to 3.536 Vrms for a sine wave.

---

**DC Offset voltage** The offset parameter can be set to MINimum, MAXimum or DEFault. The default offset is 0 volts. The offset is limited by the output amplitude as shown below.

$$|V_{offset}| < V_{max} - V_{pp}/2$$

If the output specified is out of range, the maximum offset will be set.

The offset is also determined by the output termination (50Ω or high impedance). If the offset has been set and the output termination has changed from 50Ω to high impedance, the offset will double. Changing the output termination from high impedance to 50Ω will half the offset.

<b>SOURce[1 2]:APPLy:SINusoid</b>		Source Specific Command
Description	Outputs a sine wave from the selected channel when the command has executed. Frequency, amplitude and offset can also be set.	
Syntax	SOURce[1 2]:APPLy:SINusoid [<frequency> [,<amplitude> [,<offset>] ]]	
Parameter	<frequency>	1μHz~25MHz
	<amplitude>	1mVpp~10Vpp (50Ω) (3.536 Vrms)
	<offset>	-4.99V~4.99V (50Ω)
Example	<b>SOUR1:APPL:SIN 2KHZ,MAX,MAX</b> Sets frequency to 2kHz and sets the amplitude and offset to the maximum.	

<b>SOURce[1 2]:APPLy:SQUare</b>		Source Specific Command
Description	Outputs a square wave from the selected channel when the command has executed. Frequency, amplitude and offset can also be set. The duty cycle is set to 50%.	
Syntax	SOURce[1 2]:APPLy:SQUare [<frequency> [,<amplitude> [,<offset>] ]]	
Parameter	<frequency>	1μHz~25MHz
	<amplitude>	1mVpp~10Vpp (50Ω)
	<offset>	-4.99V~4.99V (50Ω)
Example	<b>SOUR1:APPL:SQU 2KHZ,MAX,MAX</b>	

Sets frequency to 2kHz and sets the amplitude and offset to the maximum.

**SOURce[1|2]:APPLy:RAMP** Source Specific Command

---

**Description** Outputs a ramp wave from the selected channel when the command has executed. Frequency, amplitude and offset can also be set. The symmetry is set to 50%.

**Syntax** **SOURce[1|2]:APPLy:RAMP [<frequency> [,<amplitude> [,<offset>] ]]**

<b>Parameter</b>	<frequency>	1μHz~1MHz
	<amplitude>	1mVpp~10Vpp (50Ω)
	<offset>	-4.99V~4.99V (50Ω)

**Example** **SOUR1:APPL:RAMP 2KHZ,MAX,MAX**  
 Sets frequency to 2kHz and sets the amplitude and offset to the maximum.

**SOURce[1|2]:APPLy:PULSe** Source Specific Command

---

**Description** Outputs a pulse waveform from the selected channel when the command has executed. Frequency, amplitude and offset can also be set.

**Note** The PW settings from the SOURce[1|2]:PULS:WIDT command are preserved. Edge and pulse width may be adjusted to supported levels. Repetition rates will be approximated from the frequency. For accurate repetition rates, the period should be adjusted using the SOURce[1|2]:PULS:PER command

**Syntax** **SOUR[1|2]:APPLy:PULSe [<frequency> [,<amplitude> [,<offset>] ]]**

<b>Parameter</b>	<frequency>	500μHz~25MHz
	<amplitude>	1mVpp~10Vpp (50Ω)

	<code>&lt;offset&gt;</code>	-4.99V~4.99V (50Ω)
--	-----------------------------	--------------------

**Example**      **SOUR1:APPL:PULS 1KHZ,MIN,MAX**

Sets frequency to 1kHz and sets the amplitude to minimum and the and offset to the maximum.

**SOURce[1|2]:APPLy:NOISe** Source Specific Command

**Description**      Outputs Gaussian noise. Amplitude and offset can also be set.

**Note**      Frequency cannot be used with the noise function; however a value (or DEFault) must be specified. The frequency is remembered for the next function used.

**Syntax**      **SOURce[1|2]:APPLy:NOISe [<frequency|DEFault> [,<amplitude> [,<offset>] ]]**

<b>Parameter</b>	<code>&lt;frequency&gt;</code>	Not applicable
	<code>&lt;amplitude&gt;</code>	1mVpp~10Vpp (50Ω)
	<code>&lt;offset&gt;</code>	-4.99V~4.99V (50Ω)

**Example**      **SOUR1:APPL:NOIS DEF, 3.0, 1.0**

Sets the amplitude to 3 volts with an offset of 1 volt.

**SOURce[1|2]:APPLy:USER** Source Specific Command

**Description**      Outputs an arbitrary waveform from the selected channel. The output is that specified from the FUNC:USER command.

**Note**      Frequency and amplitude cannot be used with the DC function; however a value (or DEFault) must be specified. The values are remembered for the next function used.

**Syntax**      **SOURce[1|2]:APPLy:USER [<frequency> [,<amplitude> [,<offset>] ]]**

Parameter	<frequency> <amplitude> <offset>	1 $\mu$ Hz~60MHz 1mVpp~10Vpp (50 $\Omega$ ) -4.99V~4.99V (50 $\Omega$ )
Example	<b>SOUR1:APPL:USER</b>	
		Source Specific Command
<b>SOURce[1 2]:APPLy?</b>		
Description	Outputs a string with the current settings.	
Note	The string can be passed back appended to the Apply Command.	
Syntax	<b>SOURce[1 2]:APPLy?</b>	
Return Parameter	<string>	Function, frequency, amplitude, offset
Example	<b>SOUR1:APPL?</b> SIN +5.0000000000000E+03,+3.0000E+00,-2.50E+00 Returns a string with the current function and parameters, Sine, 5kHz, 3 Vpp, -2.5V offset.	

## Output Commands

---

Unlike the Apply commands, the Output commands are low level commands to program the function generator.

This section describes the low-level commands used to program the function generator. Although the APPLY command provides the most straightforward method to program the function generator, the low-level commands give you more flexibility to change individual parameters.

	Source Specific Command
<b>SOURce[1 2]:FUNction</b>	
Description	The FUNction command selects and outputs the selected output. The User parameter outputs an arbitrary waveform previously set by the SOURce[1   2]:FUNC:USER command.
Note	<p>If the function mode is changed and the current frequency setting is not supported by the new mode, the frequency setting will be altered to next highest value.</p> <p>Vpp and Vrms or dBm amplitude values may have different maximum values due to differences such as crest factor. For example, if a 5Vrms square wave is changed to a sinewave, then the Vrms is automatically adjusted to 3.536.</p> <p>The modulation, burst and sweep modes can only be used with some of the basic waveforms. If a mode is not supported, the conflicting mode will be disabled. See the table below.</p>



	Sine	Square	Ramp	Pulse	Noise	ARB
AM	✓	✓	✓	✓	×	✓
FM	✓	✓	✓	×	×	×
PM	✓	✓	✓	×	×	×
FSK	✓	✓	✓	✓	×	×
SUM	✓	✓	✓	✓	✓	×
SWEEP	✓	✓	✓	×	×	×
BURST	✓	✓	✓	×	×	×

Syntax **SOURce[1|2]:FUNCtion {SINusoid|SQUare|RAMP|PULSe|NOISe| USER}**

Example **SOUR1:FUNC SIN**  
Sets the output as a sine function.

Query Syntax **SOURce[1|2]:FUNCtion?**

Return Parameter SIN, SQU, RAMP, PULS, NOIS, USER Returns the current output type.

Example **SOUR1:FUNC?**  
SIN  
Current output is sine.

**SOURce[1|2]:FREQuency** Source Specific Command

Description The SOURce[1 | 2]:FREQuency command sets the output frequency for the selected channel. The query command returns the current frequency setting.

Note The maximum and minimum frequency depends on the function mode.

Sine, Square	1μHz~25MHz
Ramp	1μHz~1MHz
Pulse	500μHz~25MHz

Noise	Not applicable
User	1μHz~60MHz

If the function mode is changed and the current frequency setting is not supported by the new mode, the frequency setting will be altered to next highest value.

The duty cycle of square waveforms depends on the frequency settings.

1.0% to 99.0% (*frequency* ≤ 100 KHz)

10% to 90% ( $100 \text{ KHz} \leq \textit{frequency} \leq 1\text{MHz}$ )

50% (*frequency* ≤ 25 MHz)

If the frequency is changed and the set duty cycle cannot support the new frequency, the highest duty cycle available at that frequency will be used. A “settings conflict” error will result from the above scenario.

Syntax	<b>SOURce[1 2]:FREQuency</b> <b>{&lt;frequency&gt; MINimum MAXimum}</b>
--------	--

Example	<b>SOUR1:FREQ MAX</b> Sets the frequency to the maximum for the current mode.
---------	--

Query Syntax	<b>SOURce[1 2]:FREQuency?</b>
--------------	-------------------------------

Return Parameter	<NR3> Returns the frequency for the current mode.
------------------	--

Example	<b>SOUR1:FREQ? MAX</b> <b>+1.0000000000000E+06</b> The maximum frequency that can be set for the current function is 1MHz.
---------	--

---

SOURce[1 2]:AMPLitude	Source Specific Command
-----------------------	-------------------------

---

Description	The SOURce[1   2]:AMPLitude command sets the output amplitude for the selected channel. The query command returns the current amplitude settings.
-------------	---

Note	<p>The maximum and minimum amplitude depends on the output termination. The default amplitude for all functions is 100 mVpp (50Ω). If the amplitude has been set and the output termination is changed from 50Ω to high impedance, the amplitude will double. Changing the output termination from high impedance to 50Ω will half the amplitude.</p>
------	---

The offset and amplitude are related by the following equation.

$$|V_{offset}| < V_{max} - V_{pp}/2$$

If the output termination is set to high impedance, dBm units cannot be used. The units will default to Vpp.

The output amplitude can be affected by the function and unit chosen. Vpp and Vrms or dBm values may have different maximum values due to differences such as crest factor. For example, a 5Vrms square wave must be adjusted to 3.536 Vrms for a sine wave.

The amplitude units can be explicitly used each time the SOURce[1 | 2]:AMPLitude command is used. Alternatively, the VOLT:UNIT command can be used to set the amplitude units for all commands.

---

Syntax	<b>SOURce[1 2]:AMPLitude</b> {< amplitude>  MINimum MAXimum}	
Example	<b>SOUR1:AMP MAX</b> Sets the amplitude to the maximum for the current mode.	
Query Syntax	<b>SOURce[1 2]:AMPLitude?</b> {MINimum MAXimum}	
Return Parameter	<NR3>	Returns the amplitude for the current mode.
Example	<b>SOUR1:AMP? MAX</b> +5.0000E+00 The maximum amplitude that can be set for the current function is 5 volts.	

Source Specific Command

**SOURce[1|2]:DCOffset**

Description	Sets or queries the DC offset for the current mode.	
Note	<p>The offset parameter can be set to MINimum, MAXimum or DEFault. The default offset is 0 volts. The offset is limited by the output amplitude as shown below.</p> $ V_{offset}  < V_{max} - V_{pp}/2$ <p>If the output specified is out of range, the maximum offset will be set.</p> <p>The offset is also determined by the output termination (50Ω or high impedance). If the offset has been set and the output termination has changed from 50Ω to high impedance, the offset will double. Changing the output termination from high impedance to 50Ω will half the offset.</p>	

Syntax	<b>SOURce[1 2]:DCOffset</b> {< offset>  MINimum MAXimum}	
Example	<b>SOUR1:DCO MAX</b>	

	Sets the offset to the maximum for the current mode.	
Query Syntax	<b>SOURce[1 2]:DCOffset? {MINimum MAXimum}</b>	
Return Parameter	<NR3>	Returns the offset for the current mode.

**Example**      **SOUR1:DCO?**  
                   +3.0000E+00  
                   The offset for the current mode is set to +3 volts.

	Source Specific Command
<b>SOURce[1 2]:SQUare:DCYCLE</b>	
Description	Sets or queries the duty cycle for square waves only. The setting is remembered if the function mode is changed. The default duty cycle is 50%.
Note	<p>The duty cycle of square waveforms depend on the frequency settings.</p> <p>1.0% to 99.0% (<i>frequency</i> ≤ 100 KHz)            10% to 90% (100 KHz ≤ <i>frequency</i> ≤ 1MHz)            50% (<i>frequency</i> ≤ 25 MHz)</p> <p>If the frequency is changed and the set duty cycle cannot support the new frequency, the highest duty cycle available at that frequency will be used. A “settings conflict” error will result from the above scenario.</p> <p>For square waveforms, the Apply command and AM/FM modulation modes ignore the duty cycle settings.</p>
Syntax	<b>SOURce[1 2]:SQUare:DCYCLE {&lt; percent&gt;  MINimum MAXimum}</b>
Example	<p><b>SOUR1:SQU:DCYC MAX</b></p> <p>Sets the duty cycle to the highest possible for the current frequency.</p>

Query Syntax	<b>SOURce[1 2]:SQUare:DCYClE?</b> <b>{MINimum MAXimum}</b>	
Return Parameter	<NR3>	Returns the duty cycle as a percentage.
Example	<b>SOUR1:SQU:DCYC?</b> +5.00E+01 The duty cycle is set 50%.	

**SOURce[1|2]:RAMP:SYMMetry** Source Specific Command

---

Description	Sets or queries the symmetry for ramp waves only. The setting is remembered if the function mode is changed. The default symmetry is 50%.	
Note	For ramp waveforms, the Apply command and AM/FM modulation modes ignore the current symmetry settings.	
Syntax	<b>SOURce[1 2]:RAMP:SYMMetry</b> {< percent> <b> MINimum MAXimum}</b>	
Example	<b>SOUR1:RAMP:SYMM MAX</b> Sets the symmetry to the 100%.	
Query Syntax	<b>SOURce[1 2]:RAMP:SYMMetry?</b> <b>{MINimum MAXimum}</b>	
Return Parameter	<NR3>	Returns the symmetry as a percentage.
Example	<b>SOUR1:RAMP:SYMMetry?</b> +1.0000E+02 The symmetry is set as 100%.	

**OUTPut[1|2]** Source Specific Command

---

Description	Enables/Disables or queries the front panel output from the selected channel. The default is set to off.	
Note	If the output is overloaded by an external voltage,	

the output will turn off and an error message will be displayed. The overload must first be removed before the output can be turned on again with output command.

Using the Apply command automatically sets the front panel output to on.

Syntax	<b>OUTPut[1 2] {OFF ON}</b>
Example	<b>OUTP1 ON</b> Turns the channel 1 output on.
Query Syntax	<b>OUTPut[1 2]?</b>
Return Parameter	1 ON 0 OFF
Example	<b>OUTP1?</b> <b>1</b> The channel 1 output is currently on.

	Source Specific Command
<b>OUTPut[1 2]:LOAD</b>	
Description	Sets or queries the output termination. Two impedance settings can be chosen, DEFault (50 $\Omega$ ) and INFinity (high impedance >10 k $\Omega$ ).  The output termination is to be used as a reference only. If the output termination is set 50 $\Omega$ but the actual load impedance is not 50 $\Omega$ , then the amplitude and offset will not be correct.
Note	If the amplitude has been set and the output termination is changed from 50 $\Omega$ to high impedance, the amplitude will double. Changing the output termination from high impedance to 50 $\Omega$ will half the amplitude.  If the output termination is set to high impedance, dBm units cannot be used. The units will default to Vpp.
Syntax	<b>OUTPut[1 2]:LOAD {DEFault INFinity}</b>

Example	<b>OUTP1:LOAD DEF</b> Sets the channel 1 output termination to 50Ω.
Query Syntax	<b>OUTPut[1 2]:LOAD?</b>
Return Parameter	DEF Default INF INFinity
Example	<b>OUTP1:LOAD?</b> <b>DEF</b> The output termination for channel 1 is set to 50Ω.

**SOURce[1|2]:VOLTage:UNIT** Source Specific Command

---

Description	Sets or queries the output amplitude units. There are three types of units: VPP, VRMS and DBM.
Note	The units set with the VOLTage:UNIT command will be used as the default unit for all amplitude units unless a different unit is specifically used for a command.  If the output termination is set to high impedance, dBm units cannot be used. The Units will automatically default to Vpp.
Syntax	<b>SOURce[1 2]:VOLTage:UNIT {VPP VRMS DBM}</b>
Example	<b>SOUR1:VOLT:UNIT VPP</b> Sets the amplitude units to Vpp.
Query Syntax	<b>SOURce[1 2]:VOLTage:UNIT?</b>
Return Parameter	VPP Vpp VRMS Vrms DBM dBm
Example	<b>SOUR1:VOLT:UNIT?</b> <b>VPP</b> The amplitude units are set to Vpp.



## Pulse Configuration Commands

The pulse chapter is used to control and output pulse waveforms. Unlike the APPLY command, low level control is possible including setting the rise time, fall time, period and pulse width.

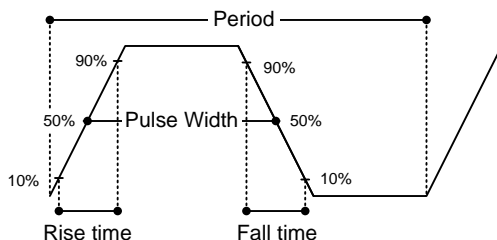

	Source Specific Command
<b>SOURCE[1 2]:PULSE:PERiod</b>	<b>Source Specific Command</b>
<b>Description</b>	Sets or queries the pulse period. The default period is 1 ms.
<b>Note</b>	<p>The pulse period must be greater than the pulse width and edge time(1.6x) combined.</p> $\text{Pulse Width} + (1.6 * \text{Edge Time}) < \text{Period}$ <p>If the edge time or pulse width are too great, they will automatically be reduced to fit the period by the function generator.</p> <p>The PULSE:PERiod function will change the period for all functions, not just for the pulse waveforms. If a different function is chosen and the current period is out of range, the period will be automatically adjusted to suit the new function.</p>
<b>Syntax</b>	<b>SOURCE[1 2]:PULSE:PERiod</b> <b>{&lt;seconds&gt; MINimum MAXimum}</b>
<b>Example</b>	<b>SOUR1:PULSE:PER MIN</b> Sets the period to the minimum time allowed.
<b>Query Syntax</b>	<b>SOURCE[1 2]:PULSE:PERiod? [MINimum MAXimum]</b>
<b>Return Parameter</b>	<seconds> 40ns~2000s

Example            **SOUR1:PULS:PER?**  
                       +1.0000E+01  
                       The period is set to 10 seconds.

**SOURce[1|2]:PULSe:WIDTh** Source Specific Command

---

Description        Sets or queries the pulse width. The default pulse width is 100us.  
                       The minimum pulse width is affected by the period time. If the period is over 20 or 200 seconds, then the minimum pulse width is 1us and 10us, respectively.  
                       Pulse width is defined as the time from the rising to falling edges (at a threshold of 50%).

Note                The pulse width cannot be less than the edge time times 1.6.  
                       Pulse Width > 1.6 \* Edge Time  
                       The pulse width must be less than the period minus the edge time (x1.6).  
                       Pulse Width < Period - (1.6 \*Edge Time)

Syntax             **SOURce[1|2]:PULSe:WIDTh**  
                       {<seconds>|MINimum|MAXimum}

Example            **SOUR1:PULS:WIDT MAX**  
                       Sets the pulse width to the maximum allowed.

Query Syntax      **SOURce[1|2]:PULSe:WIDTh? [MINimum|MAXimum]**

Return Parameter <seconds>            20 ns ~ 1999.9 seconds

Example            **SOUR1:PULS:WIDT? MIN**  
                       +8.0000E-09  
                       The pulse width is set to 8 nanoseconds.

# Amplitude Modulation (AM) Commands

## AM Overview

---

To successfully create an AM waveform, the following commands must be executed in order.

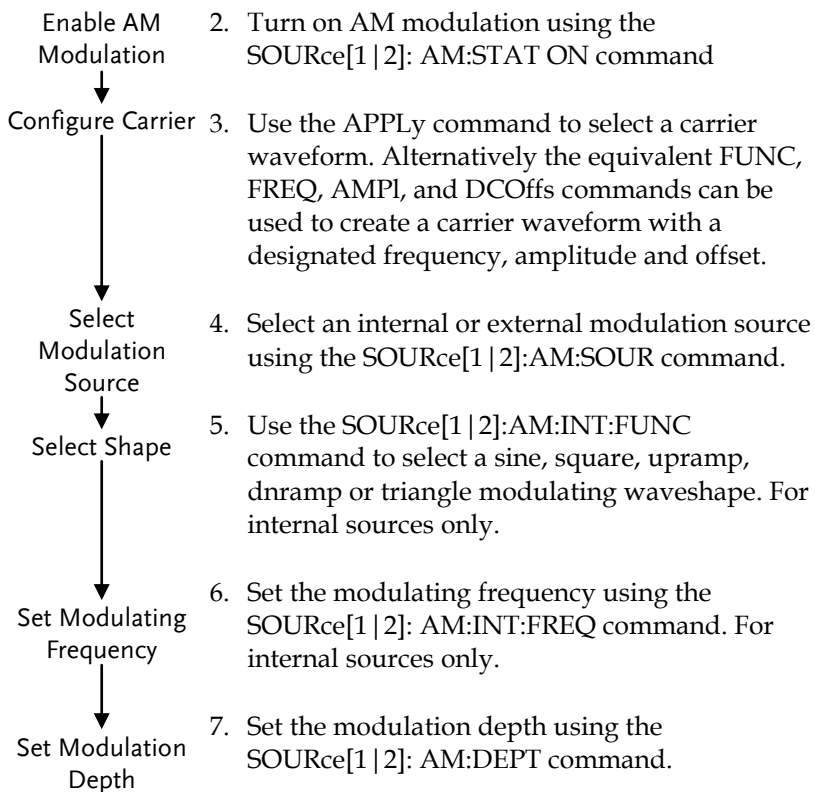

<b>SOURce[1 2]:AM:STATe</b>		Source Specific Command
Description	Sets or disables AM modulation. By default AM modulation is disabled. AM modulation must be enabled before setting other parameters.	
Note	Burst or sweep mode will be disabled if AM modulation is enabled. As only one modulation is allowed at any one time, other modulation modes will be disabled when AM modulation is enabled.	
Syntax	<b>SOURce[1 2]:AM:STATe {OFF ON}</b>	
Example	<b>SOUR1:AM:STAT ON</b> Enables AM modulation.	
Query Syntax	<b>SOURce[1 2]:AM:STATe?</b>	
Return Parameter	0	Disabled (OFF)
	1	Enabled (ON)
Example	<b>SOUR1:AM:STAT?</b> <b>1</b> AM modulation mode is currently enabled.	
<b>SOURce[1 2]:AM:SOURce</b>		Source Specific Command
Description	Sets or queries the modulation source as internal or external. Internal is the default modulation source.	
Note	If an external modulation source is selected, modulation depth is limited to $\pm 5V$ from the MOD INPUT terminal on the rear panel. For example, if modulation depth is set to 100%, then the maximum amplitude is +5V, and the minimum amplitude is -5V.	
Syntax	<b>SOURce[1 2]:AM:SOURce {INTernal EXTernal}</b>	

Example	<b>SOUR1:AM:SOUR EXT</b>			
	Sets the modulation source to external.			
Query Syntax	<b>SOURce[1 2]:AM:SOURce?</b>			
Return Parameter	INT		Internal	
	EXT		External	
Example	<b>SOUR1:AM:SOUR?</b> <b>INT</b>			
	The modulation source is set to internal.			
<b>SOURce[1 2]:AM:INTernal:FUNctIon</b>			Source Specific Command	
Description	Sets the shape of the modulating waveform from sine, square, triangle, upramp and dn ramp. The default shape is sine.			
Note	Square and triangle waveforms have a 50% duty cycle. Upramp and dn ramp have a symmetry of 100% and 0%, respectively.			
Syntax	<b>SOURce[1 2]:AM:INTernal:FUNctIon</b> <b>{SINusoid SQUare TRlangle UPRamp DNRamp}</b>			
Example	<b>SOUR1:AM:INT:FUNC SIN</b>			
	Sets the AM modulating wave shape to sine.			
Query Syntax	<b>SOURce[1 2]:AM:INTernal:FUNctIon?</b>			
Return Parameter	SIN	Sine	UPRAMP	Upramp
	SQU	Square	DNRAMP	Dn ramp
	TRI	Triangle		
Example	<b>SOUR1:AM:INT:FUNC?</b> <b>SIN</b>			
	The shape for the modulating waveform is Sine.			

<b>SOURce[1 2]:AM:INTernal:FREQuency</b>		Source Specific Command
Description	Sets the frequency of the internal modulating waveform only. The default frequency is 100Hz.	
Syntax	<b>SOURce[1 2]:AM:INTernal:FREQuency</b> <b>{&lt;frequency&gt; MINimum MAXimum}</b>	
Parameter	<frequency>	2 mHz~ 20 kHz
Example	<b>SOUR1:AM:INT:FREQ +1.0000E+02</b> Sets the modulating frequency to 100Hz.	
Query Syntax	<b>SOURce[1 2]:AM:INTernal:FREQuency?</b> <b>[MINimum MAXimum]</b>	
Return Parameter	<NR3>	Returns the frequency in Hz.
Example	<b>SOUR1:AM:INT:FREQ? MIN</b> <b>+1.0000E+02</b> Returns the minimum frequency allowed.	

<b>SOURce[1 2]:AM:DEPTh</b>		Source Specific Command
Description	Sets or queries the modulation depth for internal sources only. The default is 100%.	
Note	The function generator will not output more than $\pm 5V$ , regardless of the modulation depth. The modulation depth of an external source is controlled using the $\pm 5V$ MOD INPUT terminal on the rear panel, and not the SOURce[1 2]:AM:DEPT h command.	
Syntax	<b>SOURce[1 2]:AM:DEPT h</b> {<depth in percent> <b> MINimum MAXimum}</b>	
Parameter	<depth in percent>	0~120%
Example	<b>SOUR1:AM:DEPT 50</b> Sets the modulation depth to 50%.	

---

Query Syntax	<b>SOURce[1 2]:AM:DEPT? [MINimum MAXimum]</b>	
Return Parameter	<NR3>	Return the modulation depth as a percentage.

---

Example

**SOUR1:AM:DEPT?**  
**+1.0000E+02**

The modulation depth is 100%.

# Frequency Modulation (FM) Commands

## FM Overview

---

The following is an overview of the steps required to generate an FM waveform.

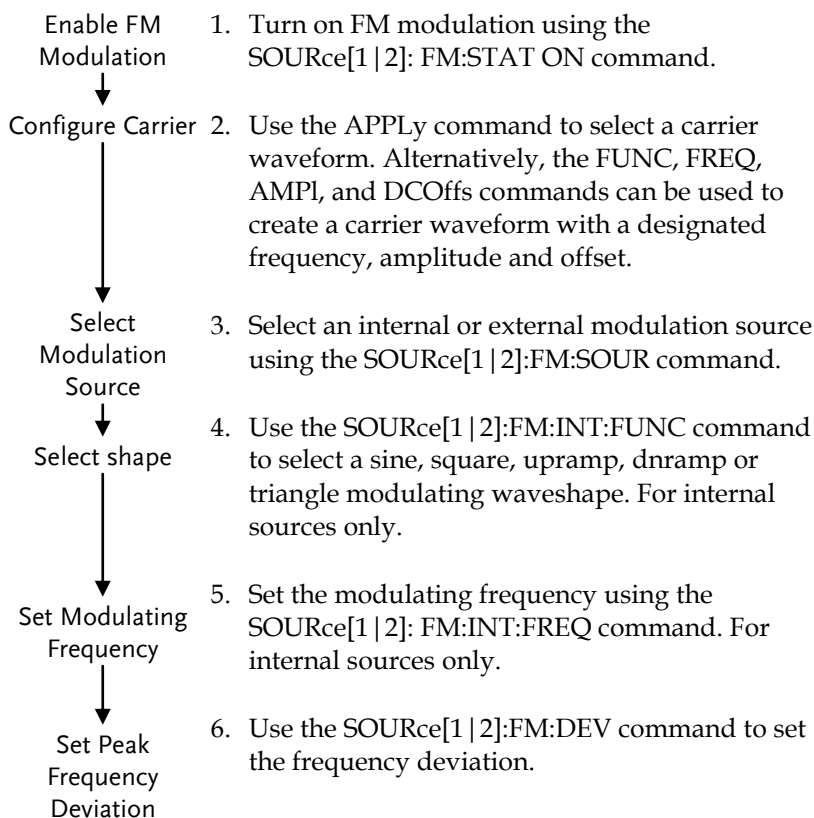



<b>SOURce[1 2]:FM:STATe</b>		Source Specific Command
Description	Sets or disables FM modulation. By default FM modulation is disabled. FM modulation must be enabled before setting other parameters.	
Note	Burst or sweep mode will be disabled if FM modulation is enabled. As only one modulation is allowed at any one time, other modulation modes will be disabled when FM modulation is enabled.	
Syntax	<b>SOUR[1 2]:FM:STATe {OFF ON}</b>	
Example	<b>SOUR1:FM:STAT ON</b> Enables FM modulation.	
Query Syntax	<b>SOURce[1 2]:FM:STATe?</b>	
Return Parameter	0	Disabled (OFF)
	1	Enabled (ON)
Example	<b>SOUR1:FM:STAT?</b> <b>1</b> FM modulation mode is currently enabled.	
<b>SOURce[1 2]:FM:SOURce</b>		Source Specific Command
Description	Sets or queries the modulation source as internal or external. Internal is the default modulation source.	
Note	If an external modulation source is selected, modulation depth is limited to $\pm 5V$ from the MOD INPUT terminal on the rear panel. For example, if modulation depth is set to 100%, then the maximum amplitude is +5V, and the minimum amplitude is -5V.	
Syntax	<b>SOURce[1 2]:FM:SOURce {INTernal EXTernal}</b>	

Example	<b>SOUR1:FM:SOUR EXT</b> Sets the modulation source to external.
Query Syntax	<b>SOURce[1 2]:FM:SOURce?</b>
Return Parameter	INT Internal EXT External
Example	<b>SOUR1:FM:SOUR?</b> <b>INT</b> The modulation source is set to internal.

**SOURce[1|2]:FM:INTernal:FUNcTion** Source Specific Command

---

Description	Sets the shape of the modulating waveform from sine, square, triangle, upramp and dn ramp. The default shape is sine.			
Note	Square and triangle waveforms have a 50% duty cycle. Upramp and dn ramp have a symmetry of 100% and 0%, respectively.			
Syntax	<b>SOURce[1 2]:FM:INTernal:FUNcTion {SINusoid SQUare TRIangle UPRamp DNRamp}</b>			
Example	<b>SOUR1:FM:INT:FUNC SIN</b> Sets the FM modulating wave shape to sine.			
Query Syntax	<b>SOURce[1 2]:FM:INTernal:FUNcTion?</b>			
Return Parameter	SIN	Sine	UPRAMP	Upramp
	SQU	Square	DNRAMP	Dn ramp
	TRI	Triangle		
Example	<b>SOUR1:FM:INT:FUNC?</b> <b>SIN</b> The shape for the modulating waveform is Sine.			

<b>SOURce[1 2]:FM:INTernal:FREQuency</b>		Source Specific Command
Description	Sets the frequency of the internal modulating waveform only. The default frequency is 10Hz.	
Syntax	<b>SOURce[1 2]:FM:INTernal:FREQuency</b> <b>{&lt;frequency&gt; MINimum MAXimum}</b>	
Parameter	<frequency>	2 mHz~ 20 kHz
Example	<b>SOUR1:FM:INT:FREQ 100</b> Sets the modulating frequency to 100Hz.	
Query Syntax	<b>SOURce[1 2]:FM:INTernal:FREQuency?</b> <b>[MINimum MAXimum]</b>	
Return Parameter	<NR3>	Returns the frequency in Hz.
Example	<b>SOUR1:FM:INT:FREQ? MAX</b> <b>+2.0000E+04</b> Returns the maximum frequency allowed.	
<b>SOURce[1 2]:FM:DEVIation</b>		Source Specific Command
Description	Sets or queries the peak frequency deviation of the modulating waveform from the carrier waveform. The default peak deviation is 100Hz.  The frequency deviation of external sources is controlled using the $\pm 5V$ MOD INPUT terminal on the rear panel. A positive signal ( $>0 \sim +5V$ ) will increase the deviation (up to the set frequency deviation), whilst a negative voltage will reduce the deviation.	
Note	The relationship of peak deviation to modulating frequency and carrier frequency is shown below. Peak deviation = modulating frequency - carrier frequency.  The carrier frequency must be greater than or	

equal to the peak deviation frequency. The sum of the deviation and carrier frequency must not exceed the maximum frequency for a specific carrier shape. If an out of range deviation is set for any of the above conditions, the deviation will be automatically adjusted to the maximum value allowed and an “out of range” error will be generated.

For square wave carrier waveforms, the deviation may cause the duty cycle frequency boundary to be exceeded. In these conditions the duty cycle will be adjusted to the maximum allowed and a “settings conflict” error will be generated.

Syntax	<b>SOURce[1 2]:FM:DEVIation {&lt;peak deviation in Hz&gt; MINimum MAXimum}</b>	
Parameter	<peak deviation in Hz>	DC~25MHz DC~15MHz(square) DC~1MHz (Ramp)
Example	<b>SOUR1:FM:DEV MAX</b> Sets the frequency deviation to the maximum value allowed.	
Query Syntax	<b>SOURce[1 2]:FM:DEVIation? [MINimum MAXimum]</b>	
Return Parameter	<NR3>	Returns the frequency deviation in Hz.
Example	<b>SOURce[1 2]:FM:DEVIation? MAX</b> <b>+1.0000E+01</b> Returns the maximum frequency deviation allowed.	

# Frequency-Shift Keying (FSK) Commands

## FSK Overview

The following is an overview of the steps required to generate an FSK modulated waveform.

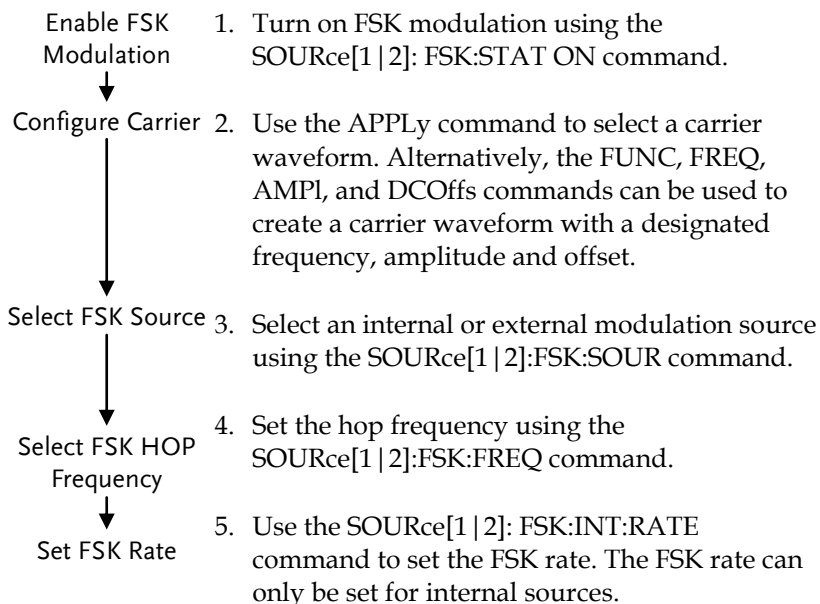

<code>SOURce[1 2]:FSKey:STATe</code>		Source Specific Command
Description	Turns FSK Modulation on or off. By default FSK modulation is off.	
Note	Burst or sweep mode will be disabled if FSK modulation is enabled. As only one modulation is allowed at any one time, other modulation modes will be disabled when FSK modulation is enabled.	
Syntax	<code>SOURce[1 2]:FSKey:STATe {OFF ON}</code>	
Example	<code>SOUR1:FSK:STAT ON</code>	

	Enables FSK modulation	
Query Syntax	<b>SOURce[1 2]:FSKey:STATe?</b>	
Return Parameter	0	Disabled (OFF)
	1	Enabled (ON)
Example	<b>SOUR1:FSK:STAT?</b> <b>1</b> FSK modulation is currently enabled.	

**SOURce[1|2]:FSKey:SOURce** Source Specific Command

---

Description	Sets or queries the FSK source as internal or external. Internal is the default source.	
Note	If an external FSK source is selected, FSK rate is controlled by the Trigger INPUT terminal on the rear panel.	
Syntax	<b>SOURce[1 2]:FSKey:SOURce {INTernal EXTernal}</b>	
Example	<b>SOUR1:FSK:SOUR EXT</b> Sets the FSK source to external.	
Query Syntax	<b>SOURce[1 2]:FSKey:SOURce?</b>	
Return Parameter	INT	Internal
	EXT	External
Example	<b>SOUR1:FSK:SOUR?</b> <b>INT</b> The FSK source is set to internal.	

**SOURce[1|2]:FSKey:FREQuency** Source Specific Command

---

Description	Sets the FSK hop frequency. The default hop frequency is set to 100Hz.	
Note	For FSK, the modulating waveform is a square wave with a duty cycle of 50%.	

Syntax	<b>SOURce[1 2]:FSKey:FREQuency</b> <b>{&lt;frequency&gt; MINimum MAXimum}</b>	
Parameter	<frequency>	1 μHz~25MHz(sine) 1 μHz~15MHz(Square、Pulse) 1 μHz~1MHz(Ramp)
Example	<b>SOUR1:FSK:FREQ +1.0000E+02</b> Sets the FSK hop frequency to to 100Hz.	
Query Syntax	<b>SOURce[1 2]:FSKey:FREQuency?</b> <b>[MINimum MAXimum]</b>	
Return Parameter	<NR3>	Returns the frequency in Hz.

Example	<b>SOUR1:FSK:FREQ? MAX</b> <b>+2.5000E+06</b> Returns the maximum hop frequency allowed.	
---------	--	--

**SOURce[1|2]:FSKey:INTernal:RATE** Source Specific Command

---

Description Sets or queries the FSK rate for internal sources only.

Note External sources will ignore this command.

Syntax **SOURce[1|2]:FSKey:INTernal:RATE** {<rate in Hz>|MINimum|MAXimum}

Parameter <rate in Hz> 2 mHz~100 kHz

Example **SOUR1:FSK:INT:RATE MAX**  
Sets the rate to the maximum (100kHz).

Query Syntax **SOURce[1|2]:FSKey:INTernal:RATE?**  
**[MINimum|MAXimum]**

Return Parameter <NR3> Returns the FSK rate in Hz.

Example

**SOUR1:FSK:INT:RATE? MAX**  
**+1.0000E+05**

Returns the maximum FSK rate allowed.



## Phase Modulation (PM) Commands

### PM Overview

---

The following is an overview of the steps required to generate a PM modulated waveform.

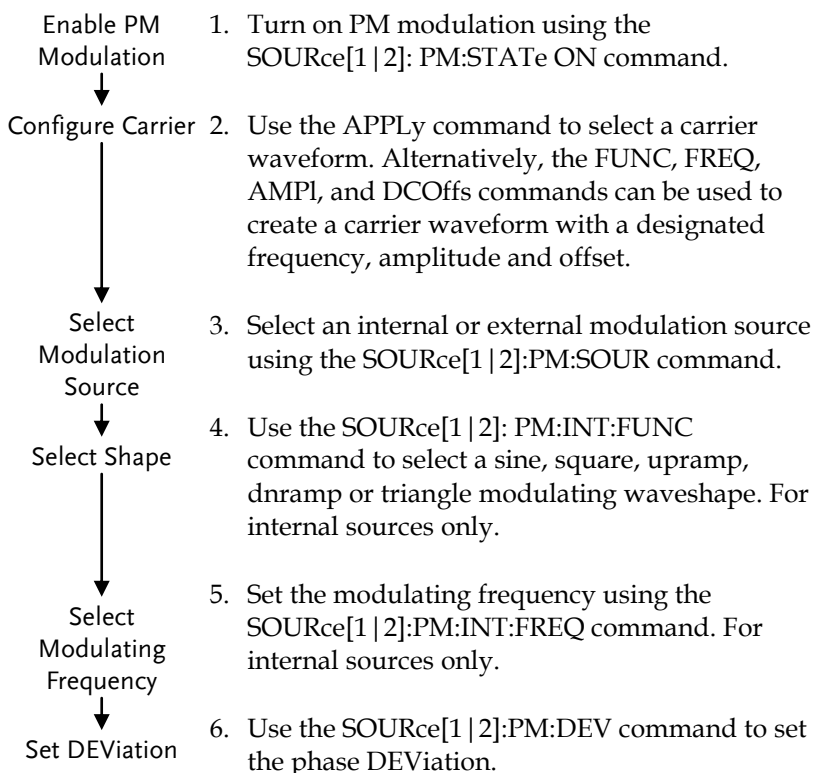

<b>SOURce[1 2]:PM:STATe</b>		Source Specific Command
Description	Turns PM Modulation on or off. By default PM modulation is off.	
Note	Burst or sweep mode will be disabled if PM modulation is enabled. As only one modulation is allowed at any one time, other modulation modes will be disabled when PM modulation is enabled.	
Syntax	<b>SOURce[1 2]:PM:STATe {OFF ON}</b>	
Example	<b>SOUR1:PM:STAT ON</b> Enables PM modulation	
Query Syntax	<b>SOURce[1 2]:PM:STATe?</b>	
Return Parameter	0	Disabled (OFF)
	1	Enabled (ON)
Example	<b>SOUR1:PM:STAT?</b> <b>1</b> PM modulation is currently enabled.	
<b>SOURce[1 2]:PM:SOURce</b>		Source Specific Command
Description	Sets or queries the PM source as internal or external. Internal is the default source.	
Note	If an external PM source is selected, the phase modulation is controlled by the MOD INPUT terminal on the rear panel.	
Syntax	<b>SOURce[1 2]:PM:SOURce {INTernal EXTernal}</b>	
Example	<b>SOUR1:PM:SOUR EXT</b> Sets the PM source to external.	
Query Syntax	<b>SOURce[1 2]:PM:SOURce?</b>	
Return Parameter	INT	Internal
	EXT	External

Example	<b>SOUR1:PM:SOUR?</b> <b>INT</b>			
	The PM source is set to internal.			
<b>SOURce[1 2]:PM:INTernal:FUNction</b>		Source Specific Command		
Description	Sets the shape of the modulating waveform from sine, square, triangle, upramp and dn ramp. The default shape is sine.			
Note	Square and triangle waveforms have a 50% duty cycle. Upramp and dn ramp have a symmetry to 100% and 0%, respectively. .			
Syntax	<b>SOURce[1 2]:PM:INTernal:FUNction</b> <b>{SINusoid SQUare TRIangle UPRamp DNRamp}</b>			
Example	<b>SOUR1:PM:INT:FUN SIN</b>			
	Sets the PM modulating wave shape to sine. .			
Query Syntax	<b>SOURce[1 2]:PM:INTernal:FUNction?</b>			
Return Parameter	SIN	Sine	UPRAMP	Upramp
	SQU	Square	DNRAMP	Dn ramp
	TRI	Triangle		
Example	<b>SOUR1:PM:INT:FUN?</b> <b>SIN</b>			
	The shape for the modulating waveform is Sine.			
<b>SOURce[1 2]:PM:INTernal:FREQuency</b>		Source Specific Command		
Description	Sets the modulating waveform frequency for internal sources. The default frequency is set to 100Hz.			
Syntax	<b>SOURce[1 2]:PM:INTernal:FREQuency</b> <b>{&lt;frequency&gt; MINimum MAXimum}</b>			
Parameter	<frequency>		2 mHz~ 20 kHz	

Example	<b>SOUR1:PM:INT:FREQ MAX</b> Sets the frequency to the maximum value.
Query Syntax	<b>SOURce[1 2]:PM:INTernal:FREQuency?</b>
Return Parameter	<NR3> Returns the frequency in Hz.
Example	<b>SOUR1:PM:INT:FREQ? MAX</b> <b>+2.0000E+04</b> Returns the modulating frequency. (20kHz)

**SOURce[1|2]:PM:DEVIation** Source Specific Command

Description	Sets or queries the phase deviation of the modulating waveform from the carrier waveform. The default phase deviation is 180°.
Note	For external sources, the phase deviation is controlled by the ±5V MOD Input terminal on the rear panel. If the phase deviation is set to 180 degrees, then +5V represents a deviation of 180 degrees. A lower input voltage will decrease the set phase deviation.
Syntax	<b>SOURce[1 2]:PM:DEVIation {&lt; phase&gt; minimum  maximum}</b>
Parameter	<percent> 0°~360°
Example	<b>SOUR1:PM:DEVIation +3.0000E+01</b> Sets the deviation to 30°.
Query Syntax	<b>SOURce[1 2]:PM:DEVIation?</b>
Return Parameter	<NR3> Returns the deviation .
Example	<b>SOUR1:PM:DEVIation?</b> <b>+3.0000E+01</b> The current deviation is 30°.

## SUM Modulation (SUM) Commands

### SUM Overview

---

The following is an overview of the steps required to generate a SUM modulated waveform.

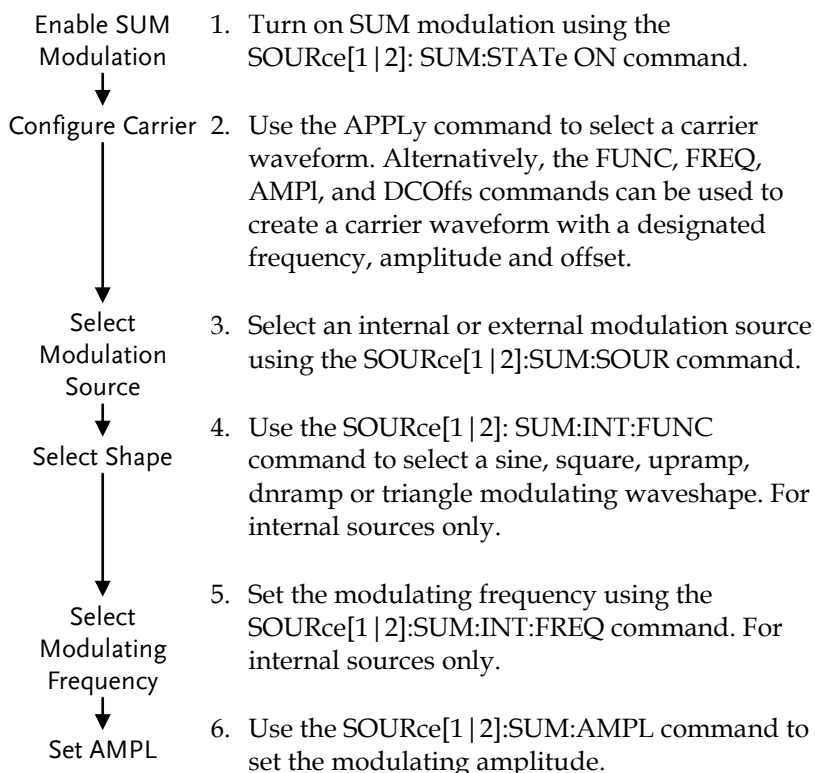

**SOURce[1|2]:SUM:STATe** Source Specific Command

---

Description	Turns SUM Modulation on or off. By default SUM modulation is off.	
Note	Burst or sweep mode will be disabled if SUM modulation is enabled. As only one modulation is allowed at any one time, other modulation modes will be disabled when SUM modulation is enabled.	
Syntax	<b>SOURce[1 2]:SUM:STATe {OFF ON}</b>	
Example	<b>SOUR1:SUM:STAT ON</b> Enables SUM modulation	
Query Syntax	<b>SOURce[1 2]:SUM:STATe?</b>	
Return Parameter	0	Disabled (OFF)
	1	Enabled (ON)
Example	<b>SOUR1:SUM:STAT?</b> <b>ON</b> SUM modulation is currently enabled.	

**SOURce[1|2]:SUM:SOURce** Source Specific Command

---

Description	Sets or queries the SUM source as internal or external. Internal is the default source.	
Note	If an external SUM source is selected, the amplitude is controlled by the MOD INPUT terminal on the rear panel.	
Syntax	<b>SOURce[1 2]:SUM:SOURce {INTernal EXTernal}</b>	
Example	<b>SOUR1:SUM:SOUR EXT</b> Sets the SUM source to external.	
Query Syntax	<b>SOURce[1 2]:SUM:SOURce?</b>	
Return Parameter	INT	Internal

	EXT	External
--	-----	----------

Example **SOUR1:SUM:SOUR?**  
**INT**  
 The SUM source is set to internal.

**SOURce[1|2]:SUM:INTernal:FUNction** Source Specific Command

---

Description Sets the shape of the modulating waveform from sine, square, triangle, upramp and dn ramp. The default shape is sine.

Note Square and triangle waveforms have a 50% duty cycle. Upramp and dn ramp have a symmetry to 100% and 0%, respectively. .

Syntax **SOURce[1|2]:SUM:INTernal:FUNction**  
**{SINusoid|SQUare|TRIangle|UPRamp|DNRamp}**

Example **SOUR1:SUM:INT:FUNC SIN**  
 Sets the SUM modulating wave shape to sine.

Query Syntax **SOURce[1|2]:SUM:INTernal:FUNction?**

Return Parameter	SIN	Sine	UPRAMP	Upramp
	SQU	Square	DNRAMP	Dn ramp
	TRI	Triangle		

Example **SOUR1:SUM:INT:FUNC?**  
**SIN**  
 The shape for the modulating waveform is Sine.

**SOURce[1|2]:SUM:INTernal:FREQuency** Source Specific Command

---

Description Sets the modulating waveform frequency for internal sources. The default frequency is set to 100Hz.

Syntax **SOURce[1|2]:SUM:INTernal:FREQuency**  
**{<frequency>|MINimum|MAXimum}**

Parameter	<frequency>	2 mHz~ 20 kHz
Example	<b>SOUR1:SUM:INT:FREQ MAX</b> Sets the frequency to the maximum value.	
Query Syntax	<b>SOURce[1 2]:SUM:INTernal:FREQuency?</b>	
Return Parameter	<NR3>	Returns the frequency in Hz.
Example	<b>SOUR1:SUM:INT:FREQ? MAX</b> <b>+2.0000E+04</b> Returns the modulating frequency (20kHz).	

### SOURce[1|2]:SUM:AMPL Source Specific Command

Description	Sets or queries the amplitude of the modulating waveform from the carrier waveform. The default phase amplitude is 50%.	
Note	If an external SUM source is selected, the amplitude of the modulated waveform is controlled using the $\pm 5V$ MOD INPUT terminal on the rear panel. A positive signal ( $>0\sim+5V$ ) will increase the AMPLitude (up to the set amplitude), whilst a negative voltage will reduce the amplitude.	
Syntax	<b>SOURce[1 2]:SUM:AMPL{&lt; percent&gt; minimum  maximum}</b>	
Parameter	<percent>	0%~100%
Example	<b>SOUR1:SUM:AMPLitude +3.0000E+01</b> Sets the amplitude to 30%.	
Query Syntax	<b>SOURce[1 2]:SUM:AMPLitude?</b>	
Return Parameter	<NR3>	Returns the amplitude .
Example	<b>SOUR1:SUM:AMPLitude?</b> <b>+3.0000E+01</b> The current amplitude is 30%.	



## Frequency Sweep Commands

### Sweep Overview

Below shows the order in which commands must be executed to perform a sweep.

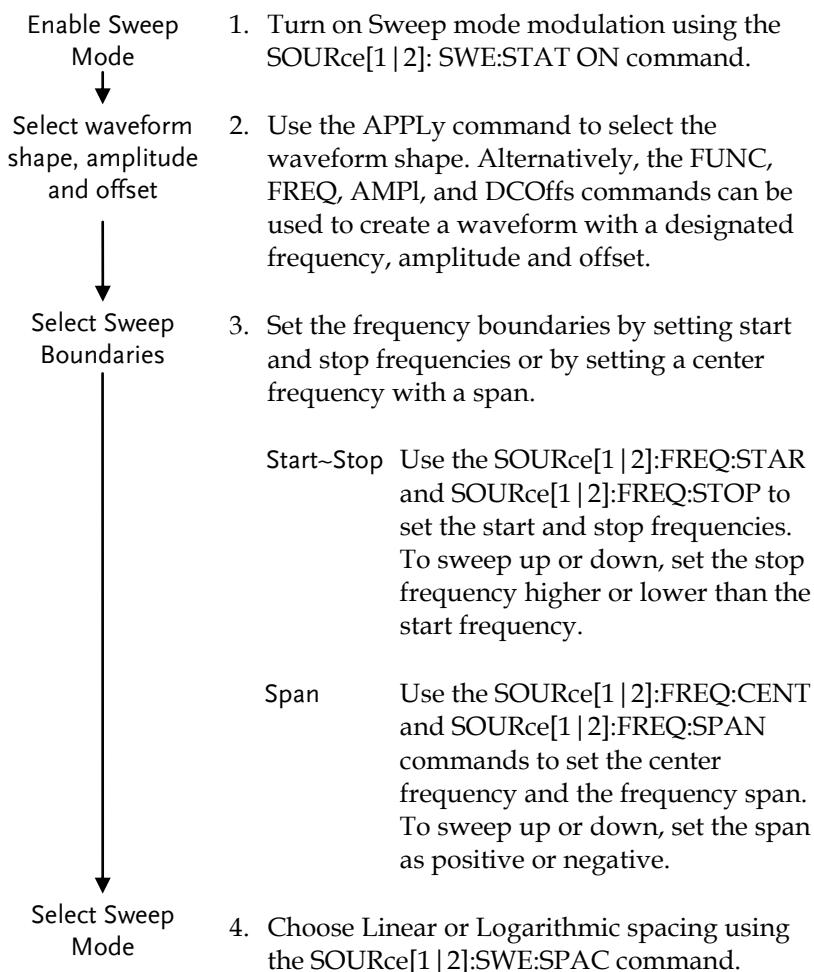

- |   |  |
|---|--|
| Select Sweep Time<br>↓<br>Select the sweep trigger source<br>↓<br>Select the marker frequency | 5. Choose the sweep time using the SOURce[1   2]:SWE:TIME command.<br><br>6. Select an internal or external sweep trigger source using the SOURce[1   2]:SOUR command.<br><br>7. To output a marker frequency from the trigger out, use The SOURce[1   2]:MARK:FREQ command. To enable marker frequency output, use the SOURce[1   2]:MARK ON command. |
|---|--|

The marker frequency can be set to a value within the sweep span.

<b>SOURce[1   2]:SWEep:STATe</b>		Source Specific Command
Description	Sets or disables Sweep mode. By default Sweep is disabled. Sweep modulation must be enabled before setting other parameters.	
Note	Any modulation modes or Burst mode will be disabled if sweep mode is enabled.	
Syntax	<b>SOURce[1 2]:SWEep:STATe {OFF ON}</b>	
Example	<b>SOUR1:SWE:STAT ON</b> Enables sweep mode.	
Query Syntax	<b>SOURce[1 2]:SWEep:STATe?</b>	
Return Parameter	0	Disabled (OFF)
	1	Enabled (ON)
Example	<b>SOUR1:SWE:STAT?</b> <b>1</b> Sweep mode is currently enabled.	

<b>SOURce[1 2]:FREQuency:STARt</b>		Source Specific Command
Description	Sets the start frequency of the sweep. 100Hz is the default start frequency.	
Note	To sweep up or down, set the stop frequency higher or lower than the start frequency.	
Syntax	<b>SOURce[1 2]:FREQuency:STARt {&lt;frequency&gt; MINimum MAXimum}</b>	
Parameter	<frequency>	1μHz~ 25MHz 1μHz~ 15MHz (Square) 1μHz~ 1MHz (Ramp)
Example	<b>SOUR1:FREQ:STAR +2.0000E+03</b> Sets the start frequency to 2kHz.	
Query Syntax	<b>SOURce[1 2]:FREQuency:STARt? [MINimum MAXimum]</b>	
Return Parameter	<NR3>	Returns the start frequency in Hz.
Example	<b>SOUR1:FREQ:STAR? MAX</b> <b>+8.0000E+0</b> Returns the maximum start frequency allowed.	
<b>SOURce[1 2]:FREQuency:STOP</b>		Source Specific Command
Description	Sets the stop frequency of the sweep. 1 kHz is the default start frequency.	
Note	To sweep up or down, set the stop frequency higher or lower than the start frequency.	
Syntax	<b>SOURce[1 2]:FREQuency:STOP {&lt;frequency&gt; MINimum MAXimum}</b>	

Parameter	<frequency>	1μHz~ 25MHz 1μHz~ 15MHz (Square) 1μHz~ 1MHz (Ramp)
-----------	-------------	--

**Example**      **SOUR1:FREQ:STOP +2.0000E+03**  
Sets the stop frequency to 2kHz.

**Query Syntax**      **SOURce[1|2]:FREQuency:STOP? [MINimum] MAXimum]**

Return Parameter	<NR3>	Returns the stop frequency in Hz.
------------------	-------	-----------------------------------

**Example**      **SOUR1:FREQ:STOP? MAX**  
**+8.0000E+00**  
Returns the maximum stop frequency allowed.

**SOURce[1|2]:FREQuency:CENTer**      Source Specific Command

**Description**      Sets and queries the center frequency of the sweep. 550 Hz is the default center frequency.

**Note**      The maximum center frequency depends on the sweep span and maximum frequency:  
 $max\ center\ freq = max\ freq - span/2$

**Syntax**      **SOURce[1|2]:FREQuency:CENTer**  
**{<frequency>|MINimum|MAXimum}**

Parameter	<frequency>	450Hz~ 25MHz 450Hz~ 15MHz (Square) 450Hz~ 1MHz (Ramp)
-----------	-------------	---

**Example**      **SOUR1:FREQ:CENT +2.0000E+03**  
Sets the center frequency to 2kHz.

**Query Syntax**      **SOURce[1|2]:FREQuency:CENTer? [MINimum] MAXimum]**

Return Parameter	<NR3>	Returns the stop frequency in Hz.
------------------	-------	-----------------------------------

Example	<b>SOUR1:FREQ:CEN? MAX +8.0000E+00</b>	
	Returns the maximum center frequency allowed, depending on the span.	
	<b>SOURce[1 2]:FREQuency:SPAN</b>	Source Specific Command
Description	Sets and queries the frequency span of the sweep. 900 Hz is the default frequency span. The span frequency is equal to the stop-start frequencies.	
Note	To sweep up or down, set the span as positive or negative.  The maximum span frequency has a relationship to the center frequency and maximum frequency: max freq span= 2(max freq - center freq)	
Syntax	<b>SOURce[1 2]:FREQuency:SPAN {&lt;frequency&gt; MINimum MAXimum}</b>	
Parameter	<frequency>	1μHz~ +/-25MHz 1μHz~ +/-15MHz(Square) 1μHz~ +/-1MHz (Ramp)
Example	<b>SOUR1:FREQ:SPAN +2.0000E+03</b>  Sets the frequency span to 2kHz.	
Query Syntax	<b>SOURce[1 2]:FREQuency:SPAN? [MINimum MAXimum]</b>	
Return Parameter	<NR3>	Returns the frequency span in Hz.
Example	<b>SOUR1:FREQ:SPAN? +2.0000E+03</b>  Returns the frequency span for the current sweep.	

<b>SOURce[1 2]:SWEep:SPACing</b>		Source Specific Command
Description	Sets linear or logarithmic sweep spacing. The default spacing is linear.	
Syntax	<b>SOURce[1 2]:SWEep:SPACing {LINear LOGarithmic}</b>	
Example	<b>SOUR1:SWE:SPAC LIN</b> Sets the spacing to linear.	
Query Syntax	<b>SOURce[1 2]:SWEep:SPACing?</b>	
Return Parameter	LIN	Linear spacing
	LOG	Logarithmic spacing
Example	<b>SOUR1:SWE:SPAC?</b> <b>LIN</b> The spacing is currently set as linear.	
<b>SOURce[1 2]:SWEep:TIME</b>		Source Specific Command
Description	Sets or queries the sweep time. The default sweep time is 1 second.	
Note	The function generator automatically determines the number of frequency points that are used for the sweep based on the sweep time.	
Syntax	<b>SOURce[1 2]:SWEep:TIME {&lt;seconds&gt; MINimum MAXimum}</b>	
Parameter	<seconds>	1 ms ~ 500 s
Example	<b>SOUR1:SWE:TIME +1.0000E+00</b> Sets the sweep time to 1 second.	
Query Syntax	<b>SOURce[1 2]:SWEep:TIME? {&lt;seconds&gt; MINimum MAXimum}</b>	
Return Parameter	<NR3>	Returns sweep time in seconds.

Example	<b>SOUR1:SWE:TIME? +2.0000E+01</b>	
	Returns the sweep time (20 seconds).	
	<b>SOURce[1 2]:SWEep:SOURce</b>	Source Specific Command
Description	Sets or queries the trigger source as immediate (internal), external or manual. Immediate (internal) is the default trigger source. IMMEDIATE will constantly output a swept waveform. EXTERNAL will output a swept waveform after each external trigger pulse. Manual will output a swept waveform after the trigger softkey is pressed.	
Note	If the APPLY command was used to create the waveform shape, the source is automatically set to IMMEDIATE.  The *OPC/*OPC? command/query can be used to signal the end of the sweep.	
Syntax	<b>SOURce[1 2]: SWEep:SOURce {IMMEDIATE EXTERNAL MANUAL}</b>	
Example	<b>SOUR1: SWE:SOUR EXT</b>	
	Sets the sweep source to external.	
Query Syntax	<b>SOURce[1 2]: SWEep:SOURce?</b>	
Return Parameter	IMM	Immediate
	EXT	External
	MANual	Manual
Example	<b>SOUR1:SWE:SOUR? IMM</b>	
	The sweep source is set to immediate.	

<b>SOURce[1 2]:MARKer:FREQuency</b>		Source Specific Command
Description	Sets or queries the marker frequency. The default marker frequency is 550 Hz. The marker frequency is used to output a trigger out signal from the trigger terminal on the rear panel.	
Note	The marker frequency must be between the start and stop frequencies. If the marker frequency is set to a value that is out of the range, the marker frequency will be set to the center frequency and a "settings conflict" error will be generated.	
Syntax	<b>SOURce[1 2]:MARKer:FREQuency {&lt;frequency&gt; MINimum MAXimum}</b>	
Parameter	<frequency>	1 μHz ~ 25 MHz 1 μHz ~ 1 MHz (Ramp)
Example	<b>SOUR1:MARK:FREQ +1.0000E+03</b> Sets the marker frequency to 1 kHz.	
Query Syntax	<b>SOURce[1 2]:MARKer:FREQuency? [MINimum MAXimum]</b>	
Return Parameter	<NR3>	Returns the marker frequency in Hz.
Example	<b>SOUR1:MARK:FREQ? MAX +1.0000E+03</b> Returns the marker frequency (1 kHz).	
<b>SOURce[1 2]:MARKer</b>		Source Specific Command
Description	Turns the marker frequency on or off. The default is off.	
Note	MARKer ON	The SYNC signal goes logically high/low at the start of each sweep and goes low/high at the marker frequency.



**MARKer OFF** The SYNC terminal outputs a square wave with a 50% duty cycle at the start of each sweep.

---

**Syntax** **SOURce[1|2]:MARKer {OFF|ON}**

---

**Example** **SOUR1:MARK ON**  
 Enables the marker frequency.

**Query Syntax** **SOURce[1|2]:MARKer?**

---

<b>Return Parameter</b>	0	Disabled
	1	Enabled

---

**Example** **SOUR1:MARK?**  
**1**  
 The marker frequency is enabled.

## Burst Mode Commands

### Burst Mode Overview

Burst mode can be configured to use an internal trigger (N Cycle mode) or an external trigger (Gate mode) using the Trigger INPUT terminal on the rear panel. Using N Cycle mode, each time the function generator receives a trigger, the function generator will output a specified number of waveform cycles (burst). After the burst, the function generator will wait for the next trigger before outputting another burst. N Cycle is the default Burst mode.

The alternative to using a specified number of cycles, Gate mode uses the external trigger to turn on or off the output. When the Trigger INPUT signal is high\*, waveforms are continuously output (creating a burst). When the Trigger INPUT signal goes low\*, the waveforms will stop being output after the last waveform completes its period. The voltage level of the output will remain equal to the starting phase of the burst waveforms, ready for the signal to go high\* again.

\*assuming the Trigger polarity is not inverted.

Only one burst mode can be used at any one time. The burst mode depends on the source of the trigger (internal, external, manual) and the source of the burst.

Burst Mode & Source	N Cycle*	Function	
		Cycle	Phase
Triggered – IMMEDIATE, BUS	Available	Available	Available
Triggered - EXTERNAL, MANUAL	Available	Unused	Available
Gated pulse - IMMEDIATE	Unused	Unused	Available

\*burst count

The following is an overview of the steps required to generate a burst waveform.

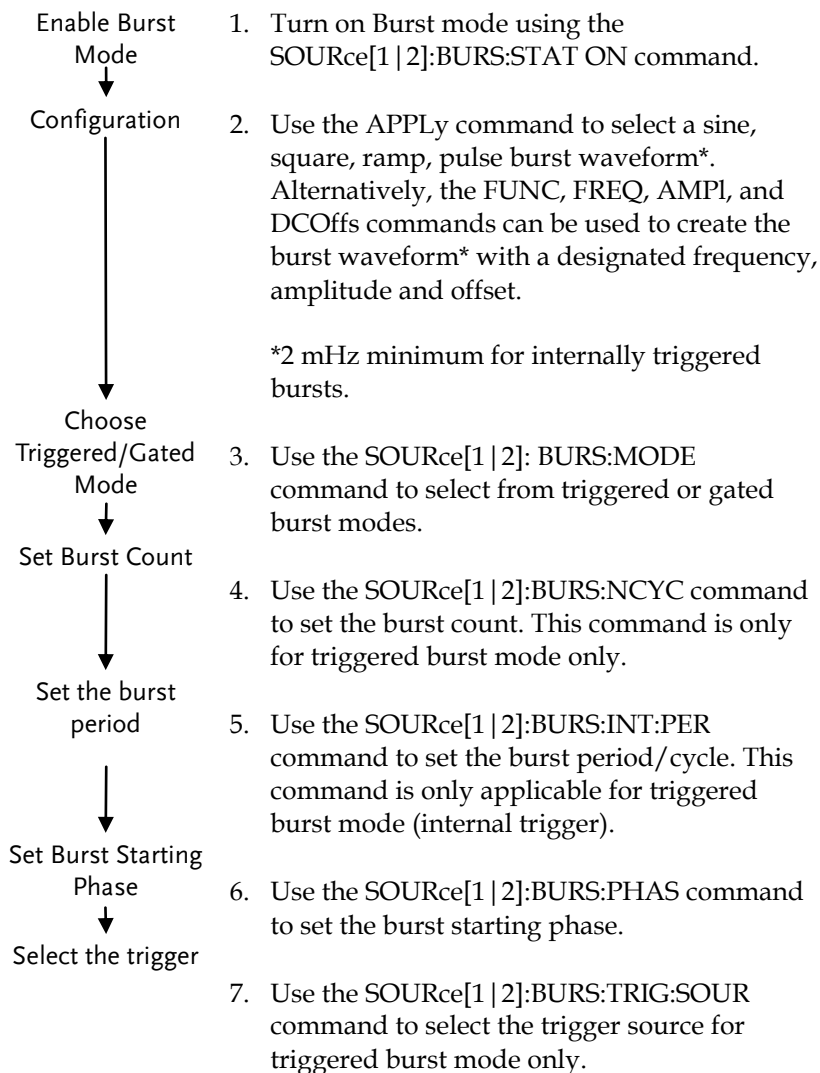

<b>SOURce[1 2]:BURSt:STATe</b>		Source Specific Command
Description	Turns burst mode on or off. By default burst mode is turned off.	
Note	When burst mode is turned on, sweep and any modulation modes are disabled.	
Syntax	<b>SOURce[1 2]:BURSt:STATe {OFF ON}</b>	
Example	<b>SOUR1:BURS:STAT ON</b> Turns burst mode on.	
Query Syntax	<b>SOURce[1 2]:BURSt:STATe?</b>	
Return Parameter	0	Disabled
	1	Enabled
Example	<b>SOUR1:BURS:STAT?</b> <b>0</b> Burst mode is off.	

<b>SOURce[1 2]:BURSt:MODE</b>		Source Specific Command
Description	Sets or queries the burst mode as gated or triggered. The default burst mode is triggered.	
Note	The burst count, period, trigger source and any manual trigger commands are ignored in gated burst mode.	
Syntax	<b>SOURce[1 2]:BURSt:MODE {TRIGgered GATed}</b>	
Example	<b>SOUR1:BURS:MODE TRIG</b> Sets the burst mode to triggered.	
Query Syntax	<b>SOURce[1 2]:BURSt:MODE?</b>	
Return Parameter	TRIG	Triggered mode
	GAT	Gated mode

Example	<b>SOUR1:BURS:MODE?</b> <b>TRIG</b>	
	The current burst mode is triggered.	
	<b>SOURce[1 2]:BURSt:NCYCles</b>	Source Specific Command
Description	Sets or queries the number of cycles (burst count) in triggered burst mode. The default number of cycles is 1. The burst count is ignored in gated mode.	
Note	<p>If the trigger source is set to immediate, the product of the burst period and waveform frequency must be greater than the burst count:                      Burst Period X Waveform frequency &gt; burst count</p> <p>If the burst count is too large, the burst period will automatically be increased and a "Settings conflict" error will be generated.</p> <p>Only sine and square waves are allowed infinite burst above 15 MHz.</p>	
Syntax	<b>SOURce[1 2]:BURSt:NCYCles{&lt; # cycles&gt; INFinity MINimum  MAXimum}</b>	
Parameter	<# cycles>	1~65535 cycles.
	INFinity	Sets the number to continuous.
	MINimum	Sets the number to minimum allowed.
	MAXimum	Sets the number to maximum allowed.
Example	<b>SOUR1:BURS:NCYCI INF</b>	
	Sets the number of burst cycles to continuous (infinite).	
Query Syntax	<b>SOURce[1 2]:BURSt:NCYCles? [MINimum MAXimum]</b>	
Return Parameter	<NR3>	Returns the number of cycles.
	INF	INF is returned if the number of cycles is continuous.

Example	<b>SOUR1:BURS:NCYC? +1.0000E+02</b> The burst cycles are set to 100.	
	<b>SOURce[1 2]:BURSt:INTernal:PERiod</b>	Source Specific Command
Description	Sets or queries the burst period. Burst period settings are only applicable when the trigger is set to immediate. The default burst period is 10 ms. During manual triggering, external triggering or Gate burst mode, the burst period settings are ignored.	
Note	The burst period must be long enough to output the designated number of cycles for a selected frequency. Burst period > burst count / (waveform frequency + 200 ns) If the period is too short, it is automatically increased so that a burst can be continuously output. A "data out of range" error will also be generated.	
Syntax	<b>SOURce[1 2]:BURSt:INTernal:PERiod {&lt;seconds&gt; MINimum MAXimum}</b>	
Parameter	<seconds> 1 ms ~ 500 seconds	
Example	<b>SOUR1:BURS:INT:PER +1.0000E+01</b> Sets the period to 10 seconds.	
Query Syntax	<b>SOURce[1 2]:BURSt:INTernal:PERiod? [MINimum MAXimum]</b>	
Return Parameter	<NR3>	Returns the burst period in seconds.
Example	<b>SOUR1:BURS:INT:PER? +1.0000E+01</b> The burst period is 10 seconds.	

<b>SOURce[1 2]:BURSt:PHASe</b>		Source Specific Command
Description	<p>Sets or queries the starting phase for the burst. The default phase is 0 degrees. At 0 degrees, sine square and ramp waveforms are at 0 volts.</p> <p>In gated burst mode, waveforms are continuously output (burst) when the Trig signal is true. The voltage level at the starting phase is used to determine the voltage level of the signal in-between bursts.</p>	
Note	The phase command is not used with pulse waveforms.	
Syntax	<b>SOURce[1 2]:BURSt:PHASe {&lt;angle&gt; MINimum MAXimum}</b>	
Parameter	<angle>	-360 ~ 360 degrees
Example	<b>SOUR1:BURSt:PHAS MAX</b> Sets the phase to 360 degrees.	
Query Syntax	<b>SOURce[1 2]:BURSt:PHASe? [MINimum MAXimum]</b>	
Return Parameter	<NR3>	Returns the phase angle in degrees.
Example	<b>SOUR1:BURSt:PHAS?</b> <b>+1.2000E+02</b> The burst phase is 120 degrees.	
<b>SOURce[1 2]:BURSt:TRIGger:SOURce</b>		Source Specific Command
Description	<p>Sets or queries the trigger source for triggered burst mode. In triggered burst mode, a waveform burst is output each time a trigger signal is received and the number of cycles is determined by the burst count.</p> <p>There are three trigger sources for triggered burst mode:</p>	

	Immediate	A burst is output at a set frequency determined by the burst period.
	External	EXTERNAL will output a burst waveform after each external trigger pulse. Any additional trigger pulse signals before the end of the burst are ignored.
	Manual	Manual triggering will output a burst waveform after the trigger softkey is pressed.
Note	<p>If the APPLY command was used, the source is automatically set to IMMEDIATE.</p> <p>The *OPC/*OPC? command/query can be used to signal the end of the burst.</p>	
Syntax	<b>SOURCE[1 2]:BURSt:TRIGger:SOURCE {IMMEDIATE EXTERNAL MANUAL}</b>	
Example	<p><b>SOUR1:BURS:TRIG:SOuR EXT</b></p> <p>Sets the burst trigger source to external.</p>	
Query Syntax	<b>SOURCE[1 2]:BURSt:TRIGger:SOURCE?</b>	
Return Parameter	IMM	Immediate
	EXT	External
	MANual	Manual
Example	<p><b>SOUR1:BURS:TRIG:SOuR?</b></p> <p><b>IMM</b></p> <p>The burst trigger source is set to immediate.</p>	
	<b>SOURCE[1 2]:BURSt:TRIGger:DELAy</b>	Source Specific Command
Description	<p>The DELAY command is used to insert a delay (in seconds) before a burst is output. The delay starts after a trigger is received. The default delay is 0 seconds.</p>	



Syntax	<b>SOURce[1 2]: BURSt:TRIGger:DElay</b> <b>{&lt;seconds&gt; MINimum MAXimum}</b>	
Parameter	<seconds>	0~655350 nS
Example	<b>SOUR1:BURSt:TRIG:DEL +1.0000E+01</b> Sets the trigger delay to 10 seconds.	
Query Syntax	<b>SOURce[1 2]:BURSt:TRIGger:DElay?</b> <b>[MINimum MAXimum]</b>	
Return Parameter	<NRf>	Delay in seconds
Example	<b>SOUR1:BURSt:TRIG:DEL ?</b> <b>+1.0000E+01</b> The trigger delay is 10 seconds.	

**SOURce[1|2]:BURSt:TRIGger:SLOPe** Source Specific Command

**Description** Sets or queries the trigger edge for externally triggered bursts from the Trigger INPUT terminal on the rear panel. By default the trigger is rising edge (Positive).

Syntax	<b>SOURce[1 2]:BURSt:TRIGger:SLOPe</b> <b>{POSitive NEGative}</b>	
Parameter	POSitive	rising edge
	NEGative	falling edge
Example	<b>SOUR1:BURSt:TRIG:SLOP NEG</b> Sets the trigger slope to negative.	
Query Syntax	<b>SOURce[1 2]:BURSt:TRIGger:SLOPe?</b>	
Return Parameter	POS	rising edge
	NEG	falling edge
Example	<b>SOUR1:BURSt:TRIG:SLOP ?</b> <b>NEG</b> The trigger slope is negative.	

**SOURce[1|2]:BURSt:GATE:POLarity** Source Specific Command

---

**Description** In gated mode, the function generator will output a waveform continuously while the external trigger receives logically true signal from the Trigger INPUT terminal. Normally a signal is logically true when it is high. The logical level can be inverted so that a low signal is considered true.

**Syntax** **SOURce[1|2]:BURSt:GATE:POLarity {NORMAL|INVertes}**

<b>Parameter</b>	NORMAL	Logically high
	INVertes	Logically low

**Example** **SOUR1:BURS:GATE:POL INV**  
Sets the state to logically low (inverted).

**Query Syntax** **SOURce[1|2]:BURSt:GATE:POLarity?**

<b>Return Parameter</b>	NORM	Normal(High) logical level
	INV	Inverted (low) logical level

**Example** **SOUR1:BURS:GATE:POL? INV**  
The true state is inverted(logically low).

**SOURce[1|2]:BURSt:OUTPut:TRIGger:SLOPe** Source Specific Command

---

**Description** Sets or queries the trigger edge of the trigger output signal. The signal is output from the trigger out terminal on the rear panel. The default trigger output slope is positive.

Immediate	50% duty cycle square wave is output at the start of each burst.
External	Trigger output disabled.
Gated mode	Trigger output disabled.

	Manual	A >1 ms pulse is output at the start of each burst.
Syntax	<b>SOURce[1 2]:BURSt:OUTPut:TRIGger:SLOPe {POSitive NEGative}</b>	
Parameter	POSitive	Rising edge.
	NEGative	Falling edge.
Example	<b>SOUR1:BURS:OUTP:TRIG:SLOP POS</b> Sets the trigger output signal slope to positive (rising edge).	
Query Syntax	<b>SOURce[1 2]:BURSt:OUTPut:TRIGger:SLOPe?</b>	
Return Parameter	POS	Rising edge.
	NEG	Falling edge.
Example	<b>SOUR1:BURS:OUTP:TRIG:SLOP?</b> <b>POS</b> The trigger output signal slope to positive.	

<b>OUTPut[1 2]:TRIGger</b>		Source Specific Command
Description	Sets or queries the trigger output signal on or off. By default the signal is disabled. When enabled, a TTL compatible square wave is output.	
Syntax	<b>OUTPut[1 2]:TRIGger {OFF ON}</b>	
Parameter	OFF	Turns the output off.
	ON	Turns the output on.
Example	<b>OUTP1:TRIG ON</b> Turns the output on.	
Query Syntax	<b>OUTPut[1 2]:TRIGger?</b>	
Return Parameter	0	Disabled
	1	Enabled
Query Example	<b>OUTP1:TRIG?</b> <b>1</b> The trigger output is enabled.	

# Arbitrary Waveform Commands

## Arbitrary Waveform Overview

---

Use the steps below to output an arbitrary waveform over the remote interface.

- |  |  |
|--|--|
| Output Arbitrary Waveform<br>↓                       | 1. Use the <code>SOURce[1   2]:FUNCTION USER</code> command to output the arbitrary waveform currently selected in memory.   |
| Select Waveform Frequency, amplitude and offset<br>↓ | 2. Use the <code>APPLY</code> command to select frequency, amplitude and DC offset. Alternatively, the <code>FUNC</code> , <code>FREQ</code> , <code>AMPL</code> , and <code>DCOffs</code> commands can be used. |
| Load Waveform Data<br>↓                              | 3. Waveform data (1 to 4096 points per waveform) can be downloaded into volatile memory using the <code>DATA:DAC</code> command. Binary integer or decimal integer values in the range of $\pm 511$ can be used. |
| Set Waveform Rate<br>↓                               | 4. The waveform rate is the product of the number of points in the waveform and the waveform frequency.  |

Rate = Hz × # points	
Range:	Rate: 120MHz
	Frequency: 60MHz
	# points: 1~4096

<b>SOURce[1 2]:FUNCTion USER</b>		Source Specific Command				
Description	Use the SOURce[1 2]:FUNCTion USER command to output the arbitrary waveform currently selected in memory. The waveform is output with the current frequency, amplitude and offset settings.					
Syntax	<b>SOURce[1 2]:FUNCTion USER</b>					
Example	<b>SOUR1:FUNC USER</b> Selects and outputs the current waveform in memory.					
<b>DATA:DAC (SOURce[1 2]:DATA:DAC)</b>		Source Specific Command				
Description	The DATA:DAC command is used to download binary or decimal integer values into memory using the IEEE-488.2 binary block format or as an ordered list of values.					
Note	<p>The integer values (<math>\pm 511</math>) correspond to the maximum and minimum peak amplitudes of the waveform. For instance, for a waveform with an amplitude of 5Vpp (0 offset), the value 511 is the equivalent of 2.5 Volts. If the integer values do not span the full output range, the peak amplitude will be limited.</p> <p>The IEEE-488.2 binary block format is comprised of three parts:</p> <table border="0"> <tr> <td style="text-align: center;"># 7 2097152</td> <td rowspan="3" style="vertical-align: middle;"> <ol style="list-style-type: none"> <li>1. Initialization character (#)</li> <li>2. Digit length (in ASCII) of the number of bytes</li> <li>3. Number of bytes</li> </ol> </td> </tr> <tr> <td style="text-align: center;"> </td> </tr> <tr> <td style="text-align: center;">1 2 3</td> </tr> </table> <p>IEEE 488.2 uses two bytes to represent waveform</p>		# 7 2097152	<ol style="list-style-type: none"> <li>1. Initialization character (#)</li> <li>2. Digit length (in ASCII) of the number of bytes</li> <li>3. Number of bytes</li> </ol>		1 2 3
# 7 2097152	<ol style="list-style-type: none"> <li>1. Initialization character (#)</li> <li>2. Digit length (in ASCII) of the number of bytes</li> <li>3. Number of bytes</li> </ol>					
1 2 3						

	data (16 bit integer). Therefore the number of bytes is always twice the number of data points.	
Syntax	<b>DATA:DAC VOLATILE, &lt;start&gt;, {&lt;binary block&gt; &lt;value&gt;, &lt;value&gt;, ... }</b>	
Parameter	<start>	Start address of the arbitrary waveform
	<binary block>	
	<value>	Decimal or integer values ±511
Example	<b>DATA:DAC VOLATILE, #210 Binary Data</b> The command above downloads 5 data values (stored in 16 bytes) using the binary block format. <b>DATA:DAC VOLATILE, 1000, 511, 200, 0, -200, -511</b> Downloads the data values (511, 200, 0, -200, -511) to address 1000.	

	<b>SOURce[1 2]:ARB:EDIT:COPY</b>	Source Specific Command
Description	Copies a segment of a waveform to a specific starting address.	
Syntax	<b>SOURce[1 2]:ARB:EDIT:COPY [ &lt;start&gt;[,&lt;length&gt;[,&lt;paste&gt;]] ]</b>	
Parameter	<start>	Start address: 0~4095
	<length>	1 ~ 4096
	<paste>	Paste address: 0~4095
Example	<b>SOUR1:ARB:EDIT:COPY 1000, 256, 1257</b> Copies 256 data values starting at address 1000 and copies them to address 1257.	

<b>SOURce[1 2]:ARB:EDIT:DELeTe</b>		Source Specific Command
Description	Deletes a segment of a waveform from memory. The segment is defined by a starting address and length.	
Note	A waveform/ waveform segment cannot be deleted when output.	
Syntax	<b>SOURce[1 2]:ARB:EDIT:DELeTe [&lt;START&gt;[,&lt;LENGTh&gt;]]</b>	
Parameter	<START>	Start address: 0~4095
	<LENGTh>	1 ~ 4096
Example	<b>SOURce1:ARB:EDIT:DEL 1000, 256</b> Deletes a section of 256 data points from the waveform starting at address 1000.	

<b>SOURce[1 2]:ARB:EDIT:DELeTe:ALL</b>		Source Specific Command
Description	Deletes all user-defined waveforms from non-volatile memory and the current waveform in volatile memory.	
Note	A waveform cannot be deleted when output.	
Syntax	<b>SOURce[1 2]:ARB:EDIT:DELeTe:ALL</b>	
Example	<b>SOUR1:ARB:EDIT:DEL:ALL</b> Deletes all user waveforms from memory.	

<b>SOURce[1 2]:ARB:EDIT:POINT</b>		Source Specific Command
Description	Edit a point on the arbitrary waveform.	
Note	A waveform/ waveform segment cannot be deleted when output.	
Syntax	<b>SOURce[1 2]:ARB:EDIT:POINT [&lt;address&gt; [, &lt;data&gt;]]</b>	
Parameter	<address>	Address of data point: 0~4095

	<data>	Value data: ± 511
--	--------	-------------------

**Example**      **SOUR1:ARB:EDIT:POIN 1000, 511**

Creates a point on the arbitrary waveform at address 1000 with the highest amplitude.

**SOURce[1|2]:ARB:EDIT:LINE** Source Specific Command

---

**Description**      Edit a line on the arbitrary waveform. The line is created with a starting address and data point and a finishing address and data point.

**Note**      A waveform/waveform segment cannot be deleted when output.

**Syntax**      **SOURce[1|2]:ARB:EDIT:LINE**  
**[<address1>,<data>,<address2>,<data2>]]]]**

<b>Parameter</b>	<address1>	Address of data point1: 0~4095
	<data1>	Value data2: ± 511
	<address2>	Address of data point2: 0~4095
	<data2>	Value data2: ± 511

**Example**      **SOUR1:ARB:EDIT:LINE 40, 50, 100, 50**

Creates a line on the arbitrary waveform at 40,50 to 100,50.

**SOURce[1|2]:ARB:EDIT:PROTect** Source Specific Command

---

**Description**      Protects a segment of the arbitrary waveform from deletion or editing.

**Syntax**      **SOURce[1|2]:ARB:EDIT:PROTect**  
**[<START>,<LENGth>]**

<b>Parameter</b>	<START>	Start address: 0~4095
	<LENGth>	1 ~ 4096

**Example**      **SOUR1:ARB:EDIT:PROT 40, 50**



Protects a segment of the waveform from address 40 for 50 data points.

**SOURce[1|2]:ARB:EDIT:PROTECT:ALL** Source Specific Command

Description Protects the arbitrary waveform currently in non-volatile memory/ currently being output.

Syntax **SOURce[1|2]:ARB:EDIT:PROTECT:ALL**

Example **SOUR1:ARB:EDIT:PROT:ALL**

**SOURce[1|2]:ARB:EDIT:UNProtect** Source Specific Command

Description Uprotects the arbitrary waveform currently in non-volatile memory/ currently being output.

Syntax **SOURce[1|2]:ARB:EDIT:UNProtect**

Example **SOUR1:ARB:EDIT:UNP**

**SOURce[1|2]:ARB:OUTPut** Source Specific Command

Description Output the current arbitrary waveform in volatile memory. A specified start and length can also be designated.

Syntax **SOURce[1|2]:ARB:OUTPut [<START>[,<LENGTH>]]**

Parameter <START> Start address\*: 0~4096

<LENGTH> Length\*: 0 ~ 4096

\* Start + Length ≤ currently output arbitrary waveform

Example **SOUR1:ARB:OUTP 20 ,200**

Outputs the current arbitrary waveform in memory.

## COUNTER

The frequency counter function can be turned on remotely to control the frequency counter.

<b>COUNTER:STATE</b>		Instrument Command
Description	Turns the frequency counter function on or off.	
Syntax	<b>COUNter:STATe {ON OFF}</b>	
Example	<b>COUNter:STATe ON</b> Turns the frequency counter on	
Query Syntax	<b>COUNter:STATe?</b>	
Return Parameter	1	ON
	0	OFF
Example	<b>COUNter:STATe?</b> 1 Turns on the frequency counter.	

<b>COUNter:GATe</b>		Instrument Command
Description	Sets the gate time for the frequency counter.	
Syntax	<b>COUNter:GATe {0.01 0.1 1 10}</b>	
Example	<b>COUNter:GATe 1</b> Sets the gate time to 1S.	
Syntax	<b>COUNter:GATe? {max min}</b>	
Example	<b>COUNter:GATe?</b> 1 Returns the gate time: 1S.	

<b>COUNter:VALue?</b>		Instrument Command
Description	Returns the current value from the frequency counter.	
Syntax	COUNter:VALue?	
Example	<b>COUNter:VALue?</b> +5.00E+02 Returns the frequency as 500Hz.	

## PHASE

The phase command remotely controls the phase and channel synchronization.

<b>SOURce[1 2]:PHASe</b>		Instrument Command
Description	Sets the phase.	
Syntax	<b>SOURce[1 2]:PHASe {&lt;phase&gt; &lt;MIN&gt; &lt;MAX&gt;}</b>	
Parameter	phase	-180~180
	min	Sets the phase to the minimum value.
	max	Sets the phase to the maximum value.
Example	<b>SOURce1:PHASe 25</b> Sets the phase of channel 1 to 25°.	
Query Syntax	<b>SOURce[1 2]:PHASe? {MAX MIN}</b>	
Return Parameter	phase	Returns the current phase.
Example	<b>SOURce1:PHASe?</b>	
	26	Returns the phase of channel 1 as 26°.

<b>SOURce[1 2]:PHASe:SYNChronize</b>		Instrument Command
Description	Synchronizes the phase of channel 1 and channel 2. SOURce1 or SOURce2 has not effect on this command.	
Syntax	<b>SOURce[1 2]:PHASe:SYNChronize</b>	
Example	<b>SOURce1:PHASe:SYNChronize</b> Synchronizes the phase of channel 1 and channel 2.	

## COUPLE

The Couple commands can be used to remotely set the frequency coupling and amplitude coupling.

**SOURce[1|2]:FREQuency:COUPle:MODE** Instrument  
Command

Description	Set the frequency coupling mode.
Syntax	<b>SOURce[1 2]:FREQuency:COUPle:MODE {Off Offset Ratio}</b>
Example	<b>SOURce1:FREQuency:COUPle:MODE Offset</b> Sets the frequency coupling mode to offset.
Query Syntax	<b>SOURce[1 2]:FREQuency:COUPle:MODE?</b>
Return Parameter	Off            Disables frequency coupling. Offset        Set frequency coupling to offset mode. Ratio         Sets frequency coupling to ratio mode.
Example	<b>SOURce1:FREQuency:COUPle:MODE?</b> Off Frequency coupling is turned off.

**SOURce[1|2]:FREQuency:COUPle:OFFSet** Instrument  
Command

Description	Sets the offset frequency when the frequency coupling mode is set to offset.
Syntax	<b>SOURce[1 2]:FREQuency:COUPle:OFFSet {frequency}</b>
Example	<b>SOURce1:FREQuency:COUPle:OFFSet 2khz</b> Sets the offset frequency to 2kHz (the frequency of CH2 minus CH1 is 2kHz).
Syntax	<b>SOURce[1 2]:FREQuency:COUPle:OFFSet?</b>
Example	<b>SOURce1:FREQuency:COUPle:OFFSet?</b>

+2.0000E+03

The offset of channel 2 from channel 1 is 2kHz.

<b>SOURce[1 2]:FREQuency:COUPle:RATio</b>		Instrument Command
Description	Sets the frequency coupling ratio when frequency coupling is set to ratio mode.	
Syntax	<b>SOURce[1 2]:FREQuency:COUPle:RATio {ratio}</b>	
Example	<b>SOURce1:FREQuency:COUPle:RATio 2</b> Set the CH2 to CH1 frequency ratio to 2.	
Query Syntax	<b>SOURce[1 2]:FREQuency:COUPle:RATio?</b>	
Example	<b>SOURce1:FREQuency:COUPle:RATio?</b> +2.0000E+00 Returns the CH2 to CH1 frequency ratio as 2.	

<b>SOURce[1 2]:AMPlitude:COUPle:STATe</b>		Instrument Command
Description	Enables or disables the amplitude coupling.	
Syntax	<b>SOURce[1 2]:AMPlitude:COUPle:STATe {ON   Off}</b>	
Example	<b>SOURce1:AMPlitude:COUPle:STATe on</b>	
Description	Turns amplitude coupling on.	
Query Syntax	<b>SOURce[1 2]:AMPlitude:COUPle:STATe?</b>	
Return Parameter	1	ON
	0	Off
Example	<b>SOURce1:AMPlitude:COUPle:STATe?</b> 1 Amplitude coupling has been enabled.	

<b>SOURce[1 2]:TRACK</b>		Instrument Command
Description	Turns tracking on or off.	
Syntax	<b>SOURce[1 2]:TRACK {ON OFF INVerted}</b>	
Example	<b>SOURce1:TRACK ON</b> Turns tracking on. Channel 2 will “track” the changes of channel 1.	
Query Syntax	<b>SOURce[1 2]:TRACK?</b>	
Return Parameter	ON	ON
	OFF	OFF
	INV	INVerted
Example	<b>SOURce1:TRACK?</b> ON Channel tracking is turned on.	

## Save and Recall Commands

Up to 10 different instrument states can be stored to non-volatile memory (memory locations 0~9).

<b>*SAV</b>	Instrument Command
Description	Saves the current instrument state to a specified save slot. When a state is saved, all the current instrument settings, functions and waveforms are also saved.
Note	The *SAV command doesn't save waveforms in non-volatile memory, only the instrument state. The *RST command will not delete saved instrument states from memory.
Syntax	<b>*SAV {0 1 2 3 4 5 6 7 8 9}</b>
Example	<b>*SAV 0</b> Save the instrument state to memory location 0.

<b>*RCL</b>	Instrument Command
Description	Recall previously saved instrument states from memory locations 0~9.
Syntax	<b>*RCL {0 1 2 3 4 5 6 7 8 9}</b>
Example	<b>*RCL 0</b> Recall instrument state from memory location 0.

<b>MEMory:STATe:DELeTe</b>	Instrument Command
Description	Delete memory from a specified memory (ARB+Setting) location.
Syntax	<b>MEMory:STATe:DELeTe {0 1 2 3 4 5 6 7 8 9}</b>



---

Example	<b>MEM:STAT:DEL 0</b>
	Delete instrument state from memory location 0.

<b>MEMory:STATe:DELeTe ALL</b>	Instrument Command
--------------------------------	-----------------------

---

Description	Delete memory from all memory locations, 0~9.
-------------	---

---

Syntax	<b>MEMory:STATe:DELeTe ALL</b>
--------	--------------------------------

---

Example	<b>MEM:STAT:DEL ALL</b>
	Deletes all the instrument states from memory locations 0~9.

## Error Messages

---

The AFG-2225 has a number of specific error codes. Use the `SYSTem:ERRor` command to recall the error codes. For more information regarding the error queue.

### Command Error Codes

---

#### -101 Invalid character

An invalid character was used in the command string. Example: #, \$, %.

```
SOURce1:AM:DEPTH MIN %
```

#### -102 Syntax error

Invalid syntax was used in the command string. Example: An unexpected character may have been encountered, like an unexpected space.

```
SOURce1:APPL:SQUare , 1
```

#### -103 Invalid separator

An invalid separator was used in the command string. Example: a space, comma or colon was incorrectly used.

```
APPL:SIN 1 1000 OR SOURce1:APPL:SQUare
```

#### -108 Parameter not allowed

The command received more parameters than were expected. Example: An extra (not needed) parameter was added to a command

```
SOURce1:APPL? 10
```

#### -109 Missing parameter

The command received less parameters than expected. Example: A required parameter was omitted.

```
SOURce1:APPL:SQUare
```

-112 Program mnemonic too long

A command header contains more than 12 characters:

OUTP:SYNCHRONIZATION ON

-113 Undefined header

An undefined header was encountered. The header is syntactically correct. Example: the header contains a character mistake.

SOUR1:AMM:DEPT MIN

-123 Exponent too large

Numeric exponent exceeds 32,000. Example:

SOURce[1 | 2]:BURSt:NCYCles 1E34000

-124 Too many digits

The mantissa (excluding leading 0's) contains more than 255 digits.

-128 Numeric data not allowed

An unexpected numeric character was received in the command. Example: a numeric parameter is used instead of a character string.

SOURce1:BURSt:MODE 123

-131 Invalid suffix

An invalid suffix was used. Example: An unknown or incorrect suffix may have been used with a parameter.

SOURce1:SWEep:TIME 0.5 SECS

-138 Suffix not allowed

A suffix was used where none were expected. Example: Using a suffix when not allowed.

SOURce1:BURSt: NCYCles 12 CYC

-148 Character data not allowed

A parameter was used in the command where not allowed. Example: A discrete parameter was used where a numeric parameter was expected.

SOUR1:MARK:FREQ ON

-158 String data not allowed

An unexpected character string was used where none were expected. Example: A character string is used instead of a valid parameter.

SOURce1:SWEep:SPACing 'TEN'

-161 Invalid block data

Invalid block data was received. Example: The number of bytes sent with the DATA:DAC command doesn't correlate to the number of bytes specified in the block header.

-168 Block data not allowed

Block data was received where block data is not allowed. Example:

SOURce1:BURSt: NCYCles #10

-170~178 expression errors

Example: The mathematical expression used was not valid.

## Execution Errors

---

### **-211 Settings conflict;infinite burst changed trigger source to MANual**

---

Example: The trigger source is changed to Immediate from manual when infinite burst mode is selected.

### **-223 Settings conflict;frequency forced duty cycle change**

---

Example: If the frequency is changed and the current Duty cannot be supported at the new frequency ,the Duty will be automatically adjusted.

---

**-221 Settings conflict; frequency reduced for ramp function**

---

Example: When the function is changed to ramp, the Output frequency is automatically reduced if over range.

---

**-221 Settings conflict; when amplitude coupling, the other channel can't be set to "power" units**

---

Example: The dBm units can not be used when amplitude coupling, the other channel uses high\_z load

---

**-221 Settings conflict; coupling has forced tracking off.**

---

Example: When coupling mode is enabled, tracking mode is automatically disabled.

---

**-221 Settings conflict; trace mode doesn't support ARB**

---

Example: When ARB mode is enabled, tracking mode is automatically disabled.

---

**-221 Settings conflict; The phase function doesn't support ARB, square wave pulse waveforms.**

---

Example: The phase function doesn't support ARB

---

**-221 Settings conflict; Burst function can not be performed under current setting**

---

Example: A burst waveform cannot be generated with the noise or pulse waveforms.

---

**-221 Settings conflict; Sweep function can not be performed under current setting.**

---

Example: A sweep waveform cannot be generated with the noise or pulse waveforms.

---

**-221 Settings conflict; Noise and ARB don't support frequency coupling**

---

Example: The frequency coupling waveform can not be generated with the noise or ARB waveforms.

---

**-221 Settings conflict;Arb doesn't support phase operation in burst mode.**

---

Example: When burst mode is enabled,the parameter of phase can not be change.

---

**-221 Settings conflict;Sweep mode doesn't support frequency coupling**

---

Example:When modulation mode is enabled,amplitude coupling mode is automatically disabled.

---

**-221 Settings conflict;Burst mode doesn't support frequency coupling.**

---

Example: When burst mode is enabled,amplitude coupling mode is automatically disabled.

---

**-221 Settings conflict;Modulation mode doesn't support frequency coupling.**

---

Example: When modulation is enabled,frequency coupling is automatically disabled.

---

**-221 Settings conflict;Tracking has forced coupling off.**

---

Example: When tracking mode is enabled,coupling mode is automatically disabled.

---

**-221 Settings conflict; Coupling can not be performed under current setting**

---

Example: When sweep mode is enabled,coupling mode is automatically disabled.

---

**-221 Settings conflict;The dBm units can not used,when load is high\_z.**

---

Example: The dBm units can not be used when the load is high\_z.

---

**-221 Settings conflict;value clipped to upper limit.**

---

Example: The parameter was set out of range. The parameter is automatically set to the maximum value allowed.

---

**-221 Settings conflict;modulation function can not be performed under current setting.**

---

Example: A modulated waveform cannot be generated with the noise or pulse waveforms.

---

**-222 Data out of range;value clipped to lower limit**

---

Example: The parameter was set out of range.The parameter is automatically set to the minimum value allowed.

---

**-222 Data out of range;amplitude**

---

Example: If the amplitude was set to a value out of range ,it is automatically set to an upper or lower limit.

---

**-222 Data out of range;offset**

---

Example: If the offset is set to a value out of range,it is automatically set to an upper or lower limit.

---

**-222 Data out of range;burst count**

---

Example: If the burst count was set to a value out of range, it is automatically set to an upper or lower limit.

---

**-222 Data out of range;FM deviation clipped to upper limit**

---

Example: If the FM dev was set to a value out of range, it is automatically set to an upper or lower limit.

---

**-222 Data out of range;Pulse width limited by period**

---

Example: If the width was set to a value out of range,it is automatically set to an upper or lower limit.

---

**-222 Data out of range;frequency**

---

Example: If the frequency was set to a value out of range,it is automatically set to an upper or lower limit.

## Query Errors

---

### **-410 Query INTERRUPTED**

---

Indicates that a command was received but the data in the output buffer from a previous command was lost.

### **-420 Query UNTERMINATED**

---

The function generator is ready to return data, however there was no data in the output buffer. For example: Using the APPLY command.

### **-430 Query DEADLOCKED**

---

Indicates that a command generates more data than the output buffer can receive and the input buffer is full. The command will finish execution, though all the data won't be kept.

## Arbitrary Waveform Errors

---

### **-770 Nonvolatile arb waveform memory corruption detected**

---

Indicates that a fault (check sum error) has occurred with the non-volatile memory that stores the arbitrary waveform data.

### **-781 Not enough memory to store new arb waveform; bad sectors**

---

Indicates that a fault (bad sectors) has occurred with the non-volatile memory that stores the arbitrary waveform data. Resulting in not enough memory to store arbitrary data.

### **-787 Not able to delete the currently selected active arb waveform**

---

Example: The currently selected waveform is being output and cannot be deleted.



---

**800 Block length must be even**

---

Example: As block data (DATA:DAC VOLATILE) uses two bytes to store each data point, there must be an even number of bytes for a data block.

## SCPI Status Register

The status registers are used to record and determine the status of the function generator.

The function generator has a number of register groups:

Questionable Status Registers

Standard Event Status Registers

Status Byte Register

As well as the output and error queues.

Each register group is divided into three types of registers: condition registers, event registers and enable registers.

### Register types

---

Condition Register	The condition registers indicate the state of the function generator in real time. The condition registers are not triggered. I.e., the bits in the condition register change in real time with the instrument status. Reading a condition register will not clear it. The condition registers cannot be cleared or set.
Event Register	The Event Registers indicate if an event has been triggered in the condition registers. The event registers are latched and will remain set unless the *CLS command is used. Reading an event register will not clear it.
Enable Register	The Enable register determines which status event(s) are enabled. Any status events that are not enabled are ignored. Enabled events are used to summarize the status of that register group.

---

## AFG-2225 Status System

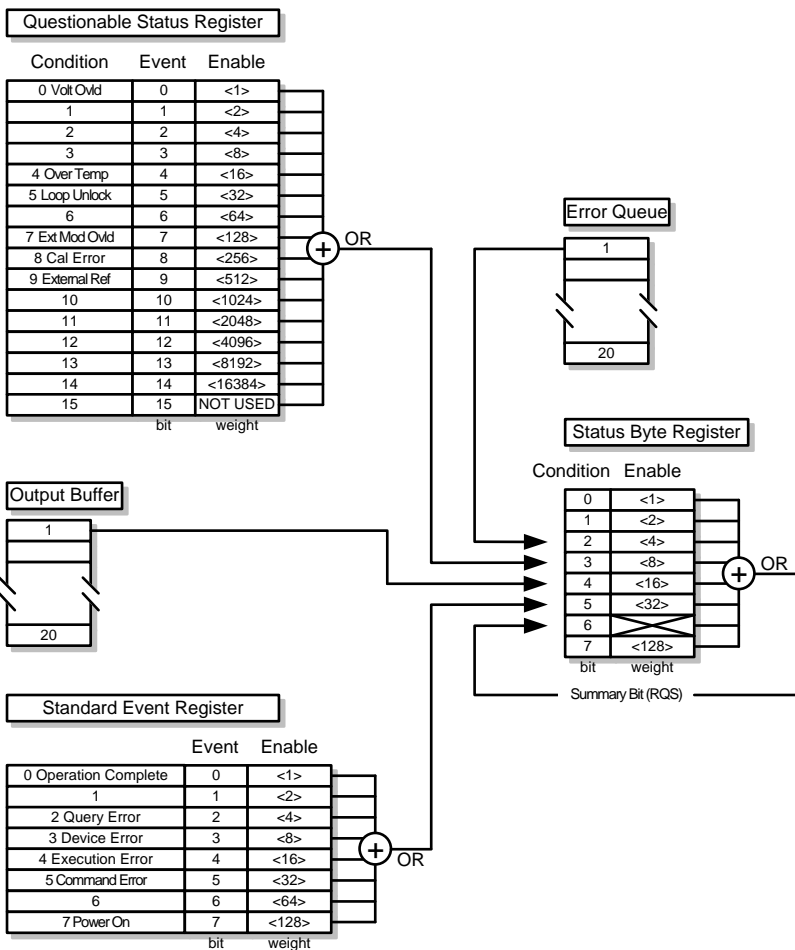

## Questionable Status Register

Description	The Questionable Status Registers will show if any faults or errors have occurred.		
Bit Summary	Register	Bit	Bit Weight
	Voltage overload	0	1
	Over temperature	4	16
	Loop unlock	5	32
	Ext Mod Overload	7	128
	Cal Error	8	256
	External Reference	9	512

## Standard Event Status Registers

Description	The Standard Event Status Registers indicate when the *OPC command has been executed or whether any programming errors have occurred.		
Notes	<p>The Standard Event Status Enable register is cleared when the *ESE 0 command is used.</p> <p>The Standard Event Status Event register is cleared when the *CLS command or the *ESR? command is used.</p>		
Bit Summary	Register	Bit	Bit Weight
	Operation complete bit	0	1
	Query Error	2	4
	Device Error	3	8
	Execution Error	4	16
	Command Error	5	32
	Power On	7	128

Error Bits	Operation complete	The operation complete bit is set when all selected pending operations are complete. This bit is set in response to the *OPC command.
	Query Error	The Query Error bit is set when there is an error reading the Output Queue. This can be caused by trying to read the Output Queue when there is no data present.
	Device Error	The Device Dependent Error indicates a failure of the self-test, calibration, memory or other device dependent error.
	Execution Error	The Execution bit indicates an execution error has occurred.
	Command Error	The Command Error bit is set when a syntax error has occurred.
	Power On	Power has been reset.

## The Status Byte Register

Description	<p>The Status Byte register consolidates the status events of all the status registers. The Status Byte register can be read with the *STB? query or a serial poll and can be cleared with the *CLS command.</p> <p>Clearing the events in any of the status registers will clear the corresponding bit in the Status Byte register.</p>
Notes	<p>The Status byte enable register is cleared when the *SRE 0 command is used.</p> <p>The Status Byte Condition register is cleared when the *CLS command is used.</p>

Bit Summary	Register	Bit	Bit Weight
	Error Queue	2	4
	Questionable Data	3	8
	Message Available	4	16
	Standard Event	5	32
	Master Summary / Request Service	6	64

Status Bits	Error Queue	There are error message(s) waiting in the error queue.
	Questionable data	The Questionable bit is set when an “enabled” questionable event has occurred.
	Message Available	The Message Available bit is set when there is outstanding data in the Output Queue. Reading all messages in the output queue will clear the message available bit.
	Standard Event	The Event Status bit is set if an “enabled” event in the Standard Event Status Event Register has occurred.
	Master Summary / Service Request bit	The Master Summary Status is used with the *STB? query. When the *STB? query is read the MSS bit is not cleared.  The Request Service bit is cleared when it is polled during a serial poll.

## Output Queue

Description	The Output queue stores output messages in a FIFO buffer until read. If the Output Queue has data, the MAV bit in the Status Byte Register is set.
-------------	--

## Error Queue

---

**Description**      The error queue is queried using the `SYSTem:ERRor?` command. The Error queue will set the “Error Queue” bit in the status byte register if there are any error messages in the error queue. If the error queue is full the last message will generate a “Queue overflow” error and additional errors will not be stored. If the error queue is empty, “No error” will be returned.

Error messages are stored in the error queue in a first-in-first-out order. The errors messages are character strings that can contain up to 255 characters.

---

# APPENDIX

## AFG-2225 Specifications

The specifications apply when the function generator is powered on for at least 30 minutes under +18°C~+28°C.

AFG-2225 models		CH1	CH2
Waveforms		Sine, Square, Ramp, Pulse, Noise, ARB	
Arbitrary Functions(1)			
	Sample Rate	120 MSa/s	
	Repetition Rate	60MHz	
	Waveform Length	4k points	
	Amplitude Resolution	10 bits	
	Non-Volatile Memory	4k points	
Frequency Characteristics			
Range	Sine	1uHz~25MHz	
	Square	1uHz~25MHz	
	Ramp	1MHz	
Resolution		1uHz	
Accuracy	Stability	±20 ppm	
	Aging	±1 ppm, per 1 year	
	Tolerance	≤1 mHz	
Output Characteristics			
Amplitude	Range	1mVpp to 10 Vpp (into 50Ω)	
		2mVpp to 20 Vpp (open-circuit)	
		1mVpp to 5 Vpp (into 50Ω) for 20MHz-25MHz	
		2mVpp to 10 Vpp (open-circuit) for 20MHz-25MHz	
	Accuracy	±2% of setting ±1 mVpp (at 1 kHz/into 50Ω without DC offset)	
	Resolution	1mV or 3 digits	
	Flatness	±1% (0.1dB) ≤100kHz ±3% (0.3 dB) ≤5MHz ±5% (0.4 dB) ≤12MHz ±10%(0.9dB) ≤25MHz (sine wave relative to 1kHz/into 50Ω)	
Units	Vpp, Vrms, dBm		



Offset	Range	±5 Vpk ac +dc (into 50Ω) ±10Vpk ac +dc (Open circuit) ±2.5 Vpk ac +dc (into 50Ω) for 20MHz-25MHz ±5Vpk ac +dc (Open circuit) for 20MHz-25MHz	
	Accuracy	2% of setting + 10mV+ 0.5% of amplitude	
	Waveform Output Impedance	50Ω typical (fixed) > 10MΩ (output disabled)	
	Protection	Short-circuit protected Overload relay automatically disables main output	
<b>Sine wave Characteristics</b>			
	Harmonic distortion	≤-55 dBc	DC ~ 200kHz, Ampl > 0.1Vpp
		≤-50 dBc	200kHz ~ 1MHz, Ampl > 0.1Vpp
		≤-35 dBc	1MHz ~ 5MHz, Ampl > 0.1Vpp
		≤-30 dBc	5MHz ~ 25MHz, Ampl > 0.1Vpp
<b>Square wave Characteristics</b>			
	Rise/Fall Time	≤25ns at maximum output. (into 50 Ω load)	
	Overshoot	5%	
	Asymmetry	1% of period +5 ns	
	Variable duty Cycle	1.0% to 99.0% ≤100kHz	
		10% to 90% ≤ 1MHz	
		50% ≤ 25MHz	
<b>Ramp Characteristics</b>			
	Linearity	< 0.1% of peak output	
	Variable Symmetry	0% to 100% (0.1% Resolution)	
<b>Pulse Characteristics</b>			
	Period	40ns~2000s	
	Pulse Width (2)	20ns~1999.9s	
	Overshoot	<5%	
	Accuracy	0.1%+20ns	
	Jitter	20ppm +10ns	
<b>AM Modulation</b>			
	Carrier Waveforms	Sine, Square, Ramp, Pulse,Arb	Sine, Square, Ramp, Pulse,Arb
	Modulating Waveforms	Sine, Square, Triangle, Upramp, Dnramp	Sine, Square, Triangle, Upramp, Dnramp
	Modulating Frequency	2mHz to 20kHz (Int) DC to 20kHz (Ext)	2mHz to 20kHz (Int) DC to 20kHz (Ext)
	Depth	0% to 120.0%	
	Source	Internal / External	
<b>FM Modulation</b>			
	Carrier Waveforms	Sine, Square, Ramp,	Sine, Square, Ramp,
	Modulating Waveforms	Sine, Square, Triangle, Upramp, Dnramp	Sine, Square, Triangle, Upramp, Dnramp

	Modulating Frequency	2mHz to 20kHz (Int) DC to 20kHz (Ext)	2mHz to 20kHz (Int) DC to 20kHz (Ext)
	Peak Deviation Source	DC to Max Frequency Internal / External	DC to Max Frequency Internal / External
<b>Sweep</b>			
	Waveforms	Sine, Square, Ramp,	Sine, Square, Ramp,
	Type	Linear or Logarithmic	Linear or Logarithmic
	Start/Stop Freq	1uHz to Max Frequency	1uHz to Max Frequency
	Sweep Time Source	1ms to 500s Internal / External/Manual	1ms to 500s Internal / External/Manual
<b>FSK</b>			
	Carrier Waveforms	Sine, Square, Ramp,Pulse	Sine, Square, Ramp,Pulse
	Modulating Waveforms	50% duty cycle square	50% duty cycle square
	Modulation Rate	2mHz to 100 kHz (INT) DC to 100 kHz(EXT)	2mHz to 100 kHz (INT) DC to 100 kHz(EXT)
	Frequency Range	1uHz to Max Frequency	1uHz to Max Frequency
	Source	Internal / External	Internal / External
<b>PM</b>			
	Carrier Waveforms	Sine, Square, Ramp	Sine, Square, Ramp
	Modulating Waveforms	Sine, Square, Triangle, Up ramp, Dn ramp	Sine, Square, Triangle, Up ramp, Dn ramp
	Modulation Frequency	2mHz to 20kHz (Int) DC to 20kHz (Ext)	2mHz to 20kHz (Int) DC to 20kHz (Ext)
	Phase deviation	0° to 360°	0° to 360°
	Source	Internal / External	Internal / External
<b>SUM</b>			
	Carrier Waveforms	Sine, Square, Ramp,Pulse,Noise	Sine, Square, Ramp,Pulse,Noise
	Modulating Waveforms	Sine, Square, Triangle, Up ramp,Dn ramp	Sine, Square, Triangle, Up ramp,Dn ramp
	Modulation Frequency	2mHz to 20kHz (Int) DC to 20kHz (Ext)	2mHz to 20kHz (Int) DC to 20kHz (Ext)
	SUM Depth	0% to 100.0%	0% to 100.0%
	Source	Internal / External	Internal / External
<b>External Trigger Input</b>			
	Type	For FSK, Burst, Sweep	
	Input Level	TTL Compatibility	
	Slope	Rising or Falling(Selectable)	
	Pulse Width	>100ns	
	Input Impedance	10kΩ, DC coupled	

<b>External Modulation Input</b>			
	Type	For AM, FM, PM, SUM	
	Voltage Range	±5V full scale	
	Input Impedance	10kΩ	
	Frequency	DC to 20kHz	
<b>Trigger Output</b>			
	Type	For Burst, Sweep, Arb	
	Level	TTL Compatible into 50Ω	
	Pulse Width	>450ns	
	Maximum Rate	1MHz	
	Fan-out	≥4 TTL Load	
	Impedance	50Ω Typical	
<b>Dual Channel Function</b>			
	Phase (3)	-180° ~180°	-180° ~ 180°
		Synchronize phase	Synchronize phase
	Track	CH2=CH1	CH1=CH2
	Coupling	Frequency(Ratio or Difference)	Frequency(Ratio or Difference)
		Amplitude & DC Offset	Amplitude & DC Offset
	Dsolink	√	√
<b>Burst</b>			
	Waveforms	Sine, Squa, Ramp,Arb	Sine, Squa,Ramp,Arb
	Frequency (4)	1uHz~15 MHz	1uHz~15 MHz
	Burst Count	1 to 65535 cycles or Infinite	1 to 65535 cycles or Infinite
	Start/Stop Phase	-360 to +360	-360 to +360
	Internal Period	1ms to 500s	1ms to 500s
	Gate Source	External Trigger	External Trigger
	Trigger Source	Single, External or Internal Rate	Single, External or Internal Rate
<b>Trigger Delay</b>	N-Cycle, Infinite	0s to 655350ns	0s to 655350ns
<b>Frequency Counter</b>			
	Range	5Hz to 150MHz	
	Accuracy	Time Base accuracy±1count	
	Time Base	±20ppm (23 °C ±5 °C) after 30 minutes warm up	
	Resolution	The maximum resolution is: 100nHz for 1Hz, 0.1Hz for 100MHz.	
	Input Impedance	1kΩ/1pf	
	Sensitivity	35mVrms ~ 30Vms (5Hz to 150MHz)	
<b>Save/Recall</b>		10 Groups of Setting Memories	
<b>Interface</b>		USB (Host&Device)	
<b>Display</b>		TFT	
<b>General Specifications</b>			
	Power Source	AC100~240V, 50~60Hz	
	Power Consumption	25 W (Max)	

Operating Environment	Temperature to satisfy the specification : 18 ~ 28 °C Operating temperature : 0 ~ 40 °C Relative Humidity: < 80%, 0 ~ 40 °C Installation category : CAT II
Operating Altitude	2000 Meters
Storage Temperature	-10~70 °C, Humidity: ≤70%
Dimensions (WxHxD)	266(W) x 107(H) x 293(D) mm
Weight	Approx. 2.5kg
Accessories	GTL-101× 2 Quick Start Guide ×1 CD (user manual + software) ×1 Power cord×1

- (1) Filter bandwidth 20MHz -3Db.
- (2) Pulse amplitude will decrease when pulse width is <50ns
- (3) Square and Pulse can not be change, Phase is 0°
- (4)
 

1uHz~15 MHz(Sine)	1uHz~15 MHz(Sine)
1uHz~15 MHz (Squa)	1uHz~15 MHz (Squa)
1uHz~1 MHz (Ramp)	1uHz~1 MHz (Ramp)

## EC Declaration of Conformity

We

**GOOD WILL INSTRUMENT CO., LTD.**

declare that the below mentioned product

**Type of Product:** 20MHz True Dual Channel Arbitrary Function  
Generator

**Model Number:** AFG-2225

is herewith confirmed to comply with the requirements set out in the Council Directive on the Approximation of the Law of Member States relating to Electromagnetic Compatibility (2014/30/EU) and Low Voltage Directive (2014/35/EU).

For the evaluation regarding the Electromagnetic Compatibility and Low Voltage Directive, the following standards were applied:

<b>© EMC</b>	
EN 61326-1: EN 61326-2-1:	Electrical equipment for measurement, control and laboratory use -- EMC requirements (2013)
Conducted & Radiated Emission EN 55011: 2009+A1: 2010	Electrical Fast Transients EN 61000-4-4: 2012
Current Harmonics EN 61000-3-2: 2014	Surge Immunity EN 61000-4-5: 2006
Voltage Fluctuations EN 61000-3-3: 2013	Conducted Susceptibility EN 61000-4-6: 2014
Electrostatic Discharge EN 61000-4-2: 2009	Power Frequency Magnetic Field EN 61000-4-8: 2010
Radiated Immunity EN 61000-4-3: 2006+A1: 2008+A2: 2010	Voltage Dip/ Interruption EN 61000-4-11: 2004
<b>Low Voltage Equipment Directive 2014/35/EU</b>	
<b>Safety Requirements</b>	<b>IEC 61010-1: 2010 (Third Edition)</b>

GOOD WILL INSTRUMENT CO., LTD.

No. 7-1, Jhongsing Road, Tucheng Dist., New Taipei City 236, Taiwan

Tel: +886-2-2268-0389

Fax: +866-2-2268-0639

Web: [www.gwinstek.com](http://www.gwinstek.com)

Email: [marketing@goodwill.com.tw](mailto:marketing@goodwill.com.tw)

GOOD WILL INSTRUMENT (SUZHOU) CO., LTD.

No. 521, Zhujiang Road, Snd, Suzhou Jiangsu 215011, China

Tel: +86-512-6661-7177

Fax: +86-512-6661-7277

Web: [www.instek.com.cn](http://www.instek.com.cn)

Email: [marketing@instek.com.cn](mailto:marketing@instek.com.cn)

GOOD WILL INSTRUMENT EURO B.V.

De Run 5427A, 5504DG Veldhoven, The Netherlands

Tel: +31(0)40-2557790

Fax: +31(0)40-2541194

Email: [sales@gw-instek.eu](mailto:sales@gw-instek.eu)

**Common**

Absatan  $y = |\text{atan}(x)|$   
The absolute of atan(x)



Abssin  $y = |\sin(x)|$   
The absolute of sin(x)



Absinehalf  $y = \sin(x), 0 < x < \pi$   
 $y = 0, \pi < x < 2\pi$   
Half\_wave function

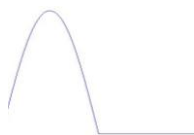

Ampalt  $y = e(x) \cdot \sin(x)$   
Oscillation rise

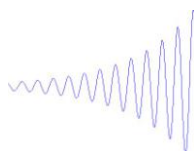

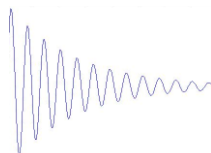

Attalt  $y = e(-x) \cdot \sin(x)$   
Oscillation down



Diric Even  
 $f(x) = -1^{(x*(n-1)/2*\pi)}$   
 $x = 0, \pm 2*\pi, \pm 4*\pi, \dots$

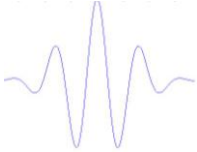
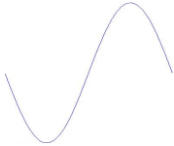
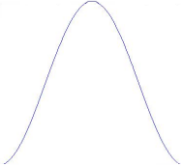

Diric	Odd $f(x)=\sin(n\pi x/2)/n\pi\sin(\pi x/2)$ $x=\pm\pi,\pm3\pi, \dots$	
Gauspuls	$f(x)=a\cdot e^{-(x-b)^2/c^2}$ Gaussian-modulated sinusoidal pulse	
Havercosine	$y=(1-\sin(x))/2$ The havercosine function	
Haversin	$y=(1-\cos(x))/2$ The haversine function	
N_pulse	Negative pulse	
Negramp	$y=-x$ Line segment	

Rectpuls      Sampled aperiodic rectangle



Roundhalf       $y=\sqrt{1-x^2}$   
The half roud

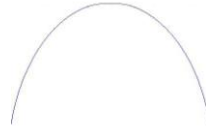

Sawtoot      Sawtooth or triangle wave

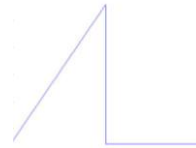

Sinetra      Piecewise function

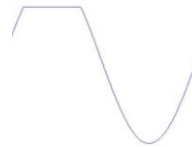

Sinever      Piecewise function

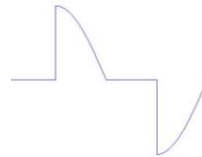

Stair\_down      Step down

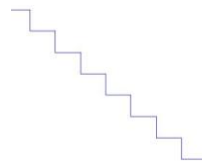



Stair\_ud      Step up and step down

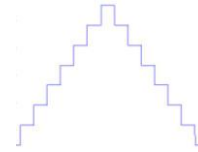

Stair\_up      Step up

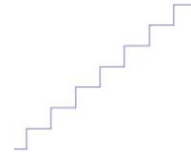

Stepresp      Heaviside step function

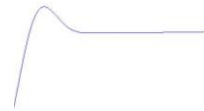

Traperia      Piecewise function

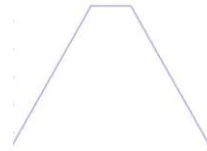

Tripuls      Sampled aperiodic triangle

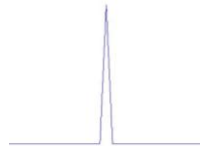

**Math**

Arccos The basic trigonometric function



Arccot The basic trigonometric function

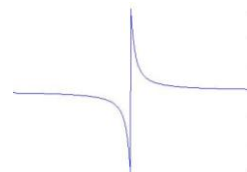

Arccsc The basic trigonometric function

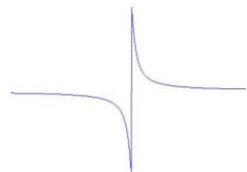

Arcsec The basic trigonometric function

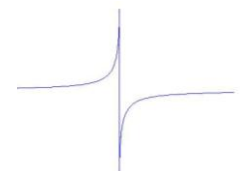

Arcsin The basic trigonometric function



Arcsinh The basic trigonometric function

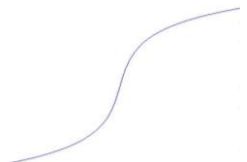

Arctan The basic trigonometric function

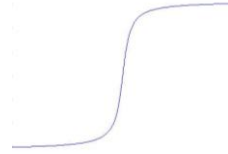

Arctanh The basic trigonometric function

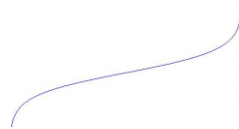

Cosh The basic trigonometric function

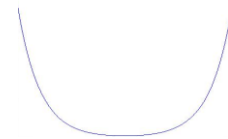

Cot The basic trigonometric function

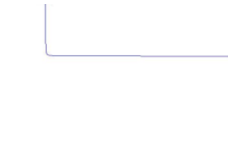

Csc The basic trigonometric function

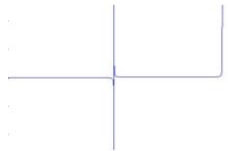

Dlorentz The derivative of the lorentz function .  
 $y = -\frac{2x}{(k*x^2+1)}$

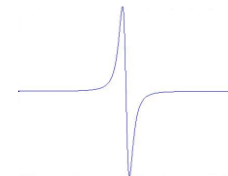

Expofall The exponential decay

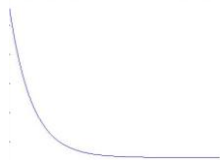

Expofrise The exponential rise



Gauss A waveform representing a gaussian bell curve

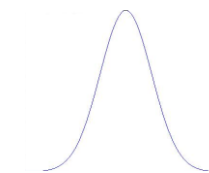

Ln The logarithm function



Lorentz The derivative of the lorentz function  
 $y=1/(k*x^2+1)$

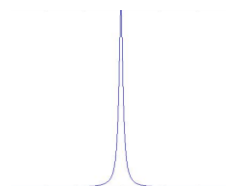

Sec The basic trigonometric function

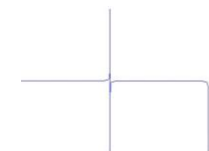

Sech The basic trigonometric function

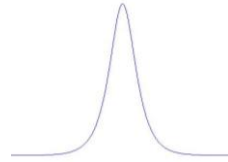

Sinec  $y = \sin(x)/x$

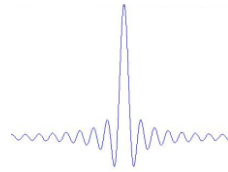

Sinh The basic trigonometric function

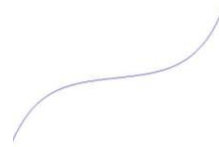

Sqrt  $y = \sqrt{x}$



Tan The basic trigonometric function



Tanh The basic trigonometric function

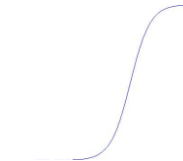

Xsquare    Parabola



## Window

Barthannwin Modified Bartlett-Hann window

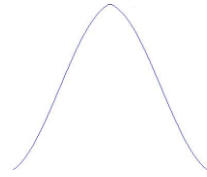

Bartlett The Bartlett window is very similar to a triangular window as returned by the triang function.

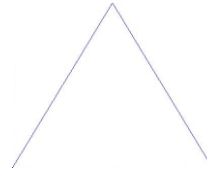

Blackman The blackman window function

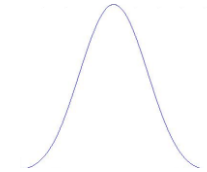

Bohmanwin The bohman window function

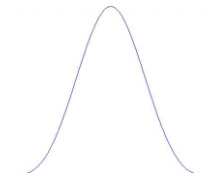

Chebyshev The chebyshev window function

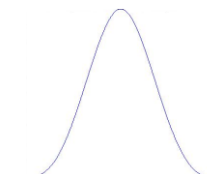

Flattopwin The flattopwin window function



Hamming      The hamming window function

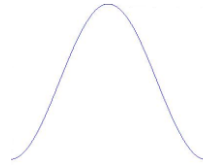

Hann          The hann window function

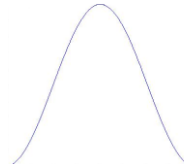

Hanning      The hanning window function

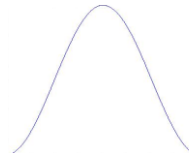

Kaiser        The kaiser window function

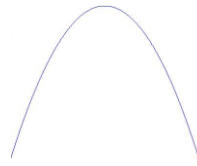

Triang        The triang window function

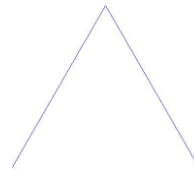

Tukeywin    The tukey window function

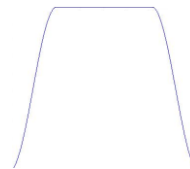



Engineer

Airy      The airy function

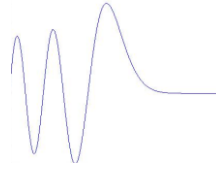

Bessel      The bessel function

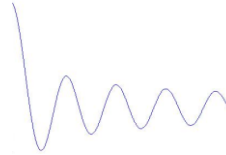

Beta      The beta function

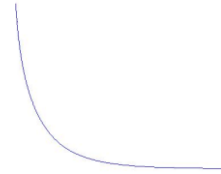

Gamm      The gamma function

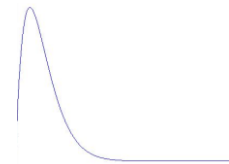

Legendre      Associated Legendre functions

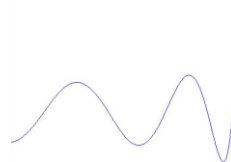

Neumann      The neumann function

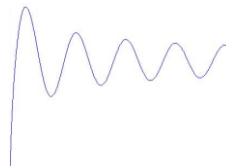

# INDEX

AM commands .....	211	FSK commands .....	221
Amplitude counter .....	134	Function keys	
Apply commands .....	194	key overview .....	12
ARB commands .....	252	Help menu .....	24
ARB error messages .....	272	lin sweep .....	109
Arbitrary waveforms .....	141	List of features .....	10
display .....	144	log sweep .....	109
edit .....	153	Menu Tree .....	42
output .....	163	Modulation .....	62
protection .....	160	AM .....	64
save and load .....	165	carrier frequency .....	66
Beeper .....	131	carrier shape .....	65
Burst commands .....	242	depth .....	70
Channel Settings .....	137	frequency .....	68
Channel tracking .....	135	shape .....	67
Cleaning the instrument .....	7	source .....	71
Command error codes .....	266	amplitude .....	102
Command list .....	183	Burst .....	114
Coupling commands .....	261	count .....	117
Declaration of conformity .....	285	delay .....	124
Default settings .....	50	frequency .....	116
Digital inputs		modes .....	115
how to use .....	22	output .....	125
Display		period .....	119
diagram .....	17	phase .....	121
DSO link .....	140	trigger .....	122
EN61010		carrier frequency .....	99
measurement category .....	7	carrier wave .....	98
pollution degree .....	8	FM .....	73
Environment			
safety instructions .....	8		
Error messages .....	266		
FM commands .....	216		
Frequency counter .....	132		
Frequency counter commands .....	258		
Frequency coupling .....	133		
Front panel diagram .....	12		

carrier frequency .....	75	Noise Wave.....	57
carrier shape .....	74	Offset .....	61
deviation.....	78	Pulse width.....	55
frequency.....	77	Ramp .....	56
shape.....	76	select waveform .....	53
source .....	79	Sine .....	53
frequency.....	101	Square.....	54
FSK .....	81	Operation keys	
carrier frequency .....	83	key overview .....	12
carrier shape .....	82	Output commands.....	200
hop frequency.....	84	Output phase.....	138
rate.....	85	Phase commands.....	260
source .....	87	Phase sync.....	139
PM.....	88	PM commands.....	225
carrier frequency .....	90	Power on/off	
carrier shape .....	90	safety instruction.....	7
deviation.....	94	Power up.....	19
frequency.....	92	Pulse configuration commands	
shape.....	91	.....	209
source .....	95	Query Errors.....	272
source.....	103	Quick reference .....	20
SUM .....	97	ARB.....	36
Sweep.....	105	burst.....	34
marker .....	111	frequency counter .....	39
mode.....	109	modulation .....	28
span .....	107	selecting a waveform.....	26
start.....	106	sweep.....	33
stop.....	106	utility .....	38
time.....	110	Rear panel diagram .....	15
trigger .....	112	Remote control .....	174
wave.....	100	interface configuration .....	175
Operation.....	52	Remote interface	
Amplitude .....	60	Error messages .....	266
Frequency .....	58	functionality check.....	176
		SCPI registers .....	274
		screen lock.....	176
		Syntax .....	178
		terminal connection .....	176
		Save and recall.....	128
		Save and Recall commands .....	264
		SCPI registers .....	274
		Screen lock .....	176
		Secondary System Settings .....	127
		System and Settings.....	131
		Service operation	
		about disassembly.....	7
		Set output impedance.....	137

---

Setting up the instrument.....	18	System commands.....	187
software download .....	176	UK power cord.....	9
Specifications .....	280	Updating Firmware.....	131
Status register commands .....	190	USB	
SUM commands .....	229	remote control interface .....	175
Sweep commands.....	233		